

RAZORWELD 350 MIG/TIG/STICK WELDER



Operating Manual | XA-MIG350WRZ



Please read and understand this instruction manual carefully before the installation and operation of this equipment.

© Xcel-Arc 2022



WARRANTY



Thank you for your purchase of your RAZORWELD 350WRZ MIG/TIG/STICK Welding Machine.

We are proud of our range of welding equipment that has a proven track record of innovation, performance and reliability.

Our product range represents the latest developments in Inverter technology put together by our professional team of highly skilled engineers. The expertise gained from our long involvement with inverter technology has proven to be invaluable towards the evolution and future development of our equipment range. This experience gives us the inside knowledge on what the arc characteristics, performance and interface between man and machine should be.

Within our team are specialist welders that have a proven history of welding knowledge and expertise, giving vital input towards ensuring that our machines deliver control and performance to the utmost professional level.

We employ an expert team of professional sales, marketing and technical personnel that provide us with market trends, market feedback and customer comments and requirements. Secondly they provide a customer support service that is second to none, thus ensuring our customers have confidence that they will be well satisfied both now and in the future.

Xcel-Arc welders and plasma cutters are manufactured to be compliant with - AS/NZ 60974-1, guaranteeing you electrical safety and performance.

WARRANTY

- 3 Years from date of purchase.
- ESSETI New Zealand Limited warranties all goods as specified by the manufacturer of those goods.
- This Warranty does not cover freight or goods that have been interfered with.
- All goods in question must be repaired by an authorised repair agent as appointed by this company.
- Warranty does not cover abuse, misuse, accident, theft, general wear and tear.
- New product will not be supplied unless ESSETI New Zealand Limited has inspected product returned for warranty and agrees to replace product.
- Product will only be replaced if repair is not possible
- Please view full Warranty term and conditions supplied with machine or at www.XcelArc.nz/warranty-terms/ or at the back of this manual.

ATTENTION! - CHECK FOR GAS LEAKAGE

At initial set up and at regular intervals we recommend to check for gas leakage

Recommended procedure is as follows:

1. Connect the regulator and gas hose assembly and tighten all connectors and clamps.
2. Slowly open the cylinder valve.
3. Set the flow rate on the regulator to approximately 8-10 L/min.
4. Close the cylinder valve and pay attention to the needle indicator of the contents pressure gauge on the regulator, if the needle drops away towards zero there is a gas leak. Sometimes a gas leak can be slow and to identify it will require leaving the gas pressure in the regulator and line for an extended time period. In this situation it is recommended to open the cylinder valve, set the flow rate to 8-10 L/min, close the cylinder valve and check after a minimum of 15 minutes.
5. If there is a gas loss then check all connectors and clamps for leakage by brushing or spraying with soapy water, bubbles will appear at the leakage point.
6. Tighten clamps or fittings to eliminate gas leakage.

IMPORTANT! - We strongly recommend that you check for gas leaks prior to operation of your machine. We recommend that you close the cylinder valve when the machine is not in use.

Esseti NZ Ltd, authorised representatives or agents of Esseti NZ Ltd will not be liable or responsible for the loss of any gas.

WARRANTY.....	2
SAFETY.....	4
RAZORWELD MIG350WRZ FEATURES.....	7
MACHINE PARTS LAYOUT.....	8
INSTALLATION SET UP FOR MMA (STICK) WELDING.....	9
MMA(STICK) WELDING GUIDE.....	10
GAS INSTALLATION & SET UP - MIG.....	12
WIRE INSTALLATION AND SET UP GUIDE.....	15
MIG WELDING GUIDE.....	20
INSTALLATION SET UP OF THE SPOOL GUN.....	26
SET UP INSTALLATION FOR PUSH PULL GUN.....	28
INSTALLATION SET UP FOR DC TIG WELDING.....	30
TIG WELDING GUIDE.....	32
GAS FLOW REGULATORS - SHEILDING GASES GAS FLOW RATES.....	37
XA36 MIG TORCH & SPARES.....	38
XASP24 SPOOL GUN & SPARES.....	40
XAP360 PUSH-PULL TORCH & SPARES.....	42
XA26V TIG TORCH & SPARES.....	44
MMA (STICK) WELDING TROUBLE SHOOTING.....	46
MIG WELDING TROUBLE SHOOTING.....	47
MIG WIRE FEED TROUBLE SHOOTING.....	48
TIG WELDING TROUBLE SHOOTING.....	49
WARRANTY TERMS.....	51
NOTES.....	54



**REGISTER YOUR MACHINE ONLINE TO RECEIVE AN
ADDITIONAL 6 MONTHS ON YOUR WARRANTY**

Visit XcelArc.nz/warranty-registration/ to register your machine.

Welding and cutting equipment can be dangerous to both the operator and people in or near the surrounding working area, if the equipment is not correctly operated. Equipment must only be used under the strict and comprehensive observance of all relevant safety regulations.

Read and understand this instruction manual carefully before the installation and operation of this equipment.

Machine Operating Safety

- Do not switch the function modes while the machine is operating. Switching of the function modes during welding can damage the machine. Damage caused in this manner will not be covered under warranty.
- Disconnect the electrode-holder cable from the machine before switching on the machine, to avoid arcing should the electrode be in contact with the work piece.
- Operators should be trained and or qualified.



Electric shock: It can kill. Touching live electrical parts can cause fatal shocks or severe burns. The electrode and work circuit is electrically live whenever the output is on. The input power circuit and internal machine circuits are also live when power is on. In MIG/MAG welding, the wire, drive rollers, wire feed housing, and all metal parts touching the welding wire are electrically live. Incorrectly installed or improperly grounded equipment is dangerous.

- Connect the primary input cable according to Australian and New Zealand standards and regulations.
- Avoid all contact with live electrical parts of the welding/cutting circuit, electrodes and wires with bare hands.
- The operator must wear dry welding gloves while he/she performs the welding/cutting task.
- The operator should keep the work piece insulated from himself/herself.
- Keep cords dry, free of oil and grease, and protected from hot metal and sparks.
- Frequently inspect input power cable for wear and tear, replace the cable immediately if damaged, bare wiring is dangerous and can kill.
- Do not use damaged, under sized, or badly joined cables.
- Do not drape cables over your body.
- We recommend (RCD) safety switch is used with this equipment to detect any leakage of current to earth.



Fumes and gases are dangerous. Smoke and gas generated whilst welding or cutting can be harmful to people's health. Welding produces fumes and gases. Breathing these fumes and gases can be hazardous to your health.

Do not breathe the smoke and gas generated whilst welding or cutting, keep your head out of the fumes

- Keep the working area well ventilated, use fume extraction or ventilation to remove welding/cutting fumes and gases.
- In confined or heavy fume environments always wear an approved air-supplied respirator.
- Welding/cutting fumes and gases can displace air and lower the oxygen level causing injury or death. Be sure the breathing air is safe.
- Do not weld/cut in locations near de-greasing, cleaning, or spraying operations. The heat and rays of the arc can react with vapours to form highly toxic and irritating gases.
- Materials such as galvanized, lead, or cadmium plated steel, containing elements that can give off toxic fumes when welded/cut. Do not weld/cut these materials unless the area is very well ventilated, and or wearing an air supplied respirator.



Arc rays: harmful to people's eyes and skin. Arc rays from the welding/cutting process produce intense visible and invisible ultraviolet and infrared rays that can burn eyes and skin.

Always wear a welding helmet with correct shade of filter lens and suitable protective clothing including welding gloves whilst the welding/cutting operation is performed.

- Measures should be taken to protect people in or near the surrounding working area. Use protective screens or barriers to protect others from flash, glare and sparks; warn others not to watch the arc.



Fire hazard. Welding/cutting on closed containers, such as tanks, drums, or pipes, can cause them to explode. Flying sparks from the welding/cutting arc, hot work piece, and hot equipment can cause fires and burns. Accidental contact of electrode to metal objects can cause sparks, explosion, overheating, or fire. Check and be sure the area is safe before doing any welding/cutting.

- The welding/cutting sparks & spatter may cause fire, therefore remove any flammable materials well away from the working area. Cover flammable materials and containers with approved covers if unable to be moved from the welding/cutting area.
- Do not weld/cut on closed containers such as tanks, drums, or pipes, unless they are properly prepared according to the required Safety Standards to insure that flammable or toxic vapours and substances are totally removed, these can cause an explosion even though the vessel has been "cleaned". Vent hollow castings or containers before heating, cutting or welding. They may explode.
- Do not weld/cut where the atmosphere may contain flammable dust, gas, or liquid vapours (such as petrol)
- Have a fire extinguisher nearby and know how to use it. Be alert that welding/cutting sparks and hot materials from welding/cutting can easily go through small cracks and openings to adjacent areas. Be aware that welding/cutting on a ceiling, floor, bulkhead, or partition can cause fire on the hidden side.



Gas Cylinders. Shielding gas cylinders contain gas under high pressure. If damaged, a cylinder can explode. Because gas cylinders are normally part of the welding/cutting process, be sure to treat them carefully. CYLINDERS can explode if damaged.

- Protect gas cylinders from excessive heat, mechanical shocks, physical damage, slag, open flames, sparks, and arcs.
- Insure cylinders are held secure and upright to prevent tipping or falling over.
- Never allow the welding/cutting electrode or earth clamp to touch the gas cylinder, do not drape welding cables over the cylinder.
- Never weld/cut on a pressurised gas cylinder, it will explode and kill you.
- Open the cylinder valve slowly and turn your face away from the cylinder outlet valve and gas regulator.



Gas build up. The build up of gas can causes a toxic environment, deplete the oxygen content in the air resulting in death or injury. Many gases use in welding/cutting are invisible and odourless.

- Shut off shielding gas supply when not in use.
- Always ventilate confined spaces or use approved air-supplied respirator.



Electronic magnetic fields. MAGNETIC FIELDS can affect Implanted Medical Devices.

- Wearers of Pacemakers and other Implanted Medical Devices should keep away.
- Implanted Medical Device wearers should consult their doctor and the device manufacturer before going near any electric welding, cutting or heating operation.



Noise can damage hearing. Noise from some processes or equipment can damage hearing.

- Wear approved ear protection if noise level is high.



Hot parts. Items being welded/cut generate and hold high heat and can cause severe burns.

Do not touch hot parts with bare hands. Allow a cooling period before working on the welding/cutting gun. Use insulated welding gloves and clothing to handle hot parts and prevent burns.

CAUTION

1. Working Environment.

- i. The environment in which this welding/cutting equipment is installed must be free of grinding dust, corrosive chemicals, flammable gas or materials etc, and at no more than maximum of 80% humidity.
- ii. When using the machine outdoors protect the machine from direct sun light, rain water and snow etc; the temperature of working environment should be maintained within -10°C to +40°C.
- iii. Keep this equipment 30cm distant from the wall.
- iv. Ensure the working environment is well ventilated.

2. Safety Tips.

i. Ventilation

This equipment is small-sized, compact in structure, and of excellent performance in amperage output. The fan is used to dissipate heat generated by this equipment during the welding/cutting operation. Important: Maintain good ventilation of the louvers of this equipment. The minimum distance between this equipment and any other objects in or near the working area should be 30 cm. Good ventilation is of critical importance for the normal performance and service life of this equipment.

ii. Thermal Overload protection.

Should the machine be used to an excessive level, or in high temperature environment, poorly ventilated area or if the fan malfunctions the Thermal Overload Switch will be activated and the machine will cease to operate. Under this circumstance, leave the machine switched on to keep the built-in fan working to bring down the temperature inside the equipment. The machine will be ready for use again when the internal temperature reaches safe level.

iii. Over-Voltage Supply

Regarding the power supply voltage range of the machine, please refer to "Main parameter" table. This equipment is of automatic voltage compensation, which enables the maintaining of the voltage range within the given range. In case that the voltage of input power supply amperage exceeds the stipulated value, it is possible to cause damage to the components of this equipment. Please ensure your primary power supply is correct.

- iv. Do not come into contact with the output terminals while the machine is in operation. An electric shock may possibly occur.

MAINTENANCE

Exposure to extremely dusty, damp, or corrosive air is damaging to the welding/cutting machine. In order to prevent any possible failure or fault of this welding/cutting equipment, clean the dust at regular intervals with clean and dry compressed air of required pressure.

Please note that: lack of maintenance can result in the cancellation of the guarantee; the guarantee of this welding/cutting equipment will be void if the machine has been modified, attempt to take apart the machine or open the factory-made sealing of the machine without the consent of an authorized representative of the manufacturer.

TROUBLE SHOOTING

Caution: Only qualified technicians are authorized to undertake the repair of this welding/cutting equipment. For your safety and to avoid Electrical Shock, please observe all safety notes and precautions detailed in this manual.

INSTALLATION & OPERATION

Please install the machine strictly according to the steps. The protection class of this machine is IP21S, so avoid using it in rain.

CONNECTION OF INPUT CABLES

Primary input cable is supplied with this welding equipment. Connect the primary input cable with power supply of required input voltage. Refer to data plate on machine for Input voltage, IMAX and IIEFF.

RAZORWELD MIG350WRZ FEATURES

RazorWeld

Welds: Steels, Stainless, Cast Iron, Bronze, Aluminium, Copper

350 Amp MIG/TIG/MMA DC Inverter Welder

Features

- Proven IGBT inverter technology
- MIG/MAG with Gas and Gasless wire capability
 - Soft Start
 - Adjustable Burn Back
 - Wire Inch
 - Internal 4 roll geared wire feeder
 - Stepless voltage and wire feed control
 - Excellent welding with CO₂ gas
 - Euro style Mig Torch connection
 - Spool Gun connection
 - Push-Pull Gun Ready
- MMA function (stick electrode)
 - VRD (Voltage Reduction Device)
 - Hot start (improves electrode starting)
 - Arc Force (boosts arc energy to prevent electrode extinguishing)
- DC-TIG
 - Lift Arc ignition (prevents tungsten sticking during arc ignition)
 - Ultra smooth DC-TIG welding current
- Digital Amp - Volt Meters
- Semi industrial application
- Tolerant to variable power supply

XA-MIG350WRZ
Standard Package



Optional machine accessories, Spool Guns, Push Pull Torches,
Tig Torch Kits available - refer www.xcelarc.nz



Technical Data

Power Supply	415V 3-Phase +/- 15%
Rated Input Power MIG	13.9 kVA
Rated Input Power MMA	15.0 kVA
I _{eff} as per AS/NZ60974-1	13.2 Amps
I Max	20.9 Amps
Output Current Range MIG	50A/16.5V - 350A/31.5V
TIG	20A/10.8V - 350A/24.0V
MMA	20A/20.8V - 350A/34.0V
Duty Cycle @ 40°C as per AS/NZ60974-1	40% @ 350 Amps MIG 40% @ 350 Amps TIG 40% @ 350 Amps MMA
Duty Cycle @ 25°C (approximate)	70% @ 350 Amps MIG 70% @ 350 Amps TIG 70% @ 350 Amps MMA
Wire Feeder	Gear Driven 4-Roll
Wire Spool Capacity	15 kg (Ø 300mm)
Wire Diameter Range	0.8, 0.9, 1.0, 1.2, 1.6mm
Efficiency	85%
Protection Class	IP21S
Dimensions (LxWxH)	900 x 400 x 785mm
Weight	60 kg
Certification Approval	AS/NZ60974-1

Overview

The MIG350WRZ is an inverter-based multi-function Mig welding machine with added MMA and Tig function. The Mig function allows you to weld with both Gas Shielded and Gasless wire applications. Easy step less adjustment of voltage and wire feed make for easy setting of welding parameters giving excellent, professional welding results. Wire inch gives easy feeding of the wire during set up without gas wastage and the Burn Back adjustment leaves the wire stick out ready for the next weld. An additional feature is the Spoolgun ready function that allows the simple connection of the XASP36 Spoolgun for the use of thin or softer wires that don't have the column strength to feed through standard mig torches, such as aluminium wire. Added MMA welding capability delivers easy and high quality welding using electrodes, including cast Iron, stainless and low hydrogen. Connection of the 26V tig torch provides quality DC Tig with Lift Arc start for welding of steel, stainless steel and copper. The machine is industrial rated and of solid construction, large industrial wheels allows easy and smooth manoeuvrability. Ideal for general engineers, maintenance workshop, rural workshop, training schools, panel beaters., Designed and built to our specification and manufactured in compliance to AS/NZ60974-1.

Product Code: XA-MIG350WRZ-K

Standard Package includes: MIG350WRZ Machine, XA36 Mig Torch x 4m, Earth Lead & Arc Lead 25mm x 4m, Argon Regulator

MACHINE PARTS LAYOUT



FRONT PANEL LAYOUT

1. Amperage Meter
2. Voltage Meter
3. Wire Inch Button.
4. MIG/MMA/TIG Mode Selector Switch.
5. Wire Feed Adjustment Knob (MIG/MAG).
6. Standard Mig / Spoolgun Selector Switch.
7. ⊖ Output terminal
8. SpoolGun Power Supply Connection
9. ⊕ Output terminal
10. Euro Mig Torch Connector (MIG/MAG)
11. Voltage Adjustment Knob (MIG/MAG)
12. Amperage Adjustment Knob (MMA/TIG)
13. Thermal Overload LED
14. Mains Power LED
15. VRD LED
16. Weld Mode Selector Switch
17. Inductance Adjustment Knob

BACK PANEL LAYOUT

18. Power switch
19. Input power cable
20. Data Plate
21. Gas Inlet
22. Fan

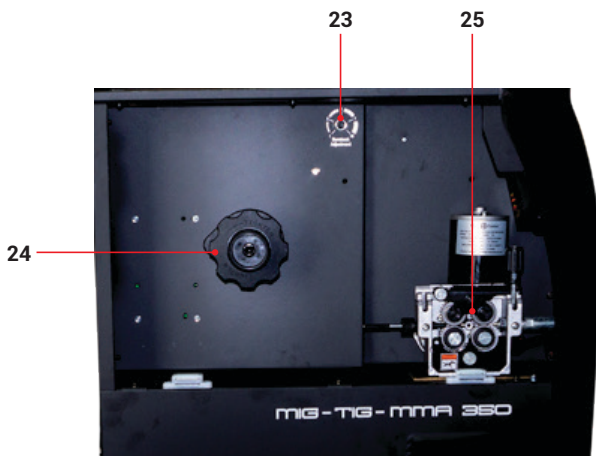
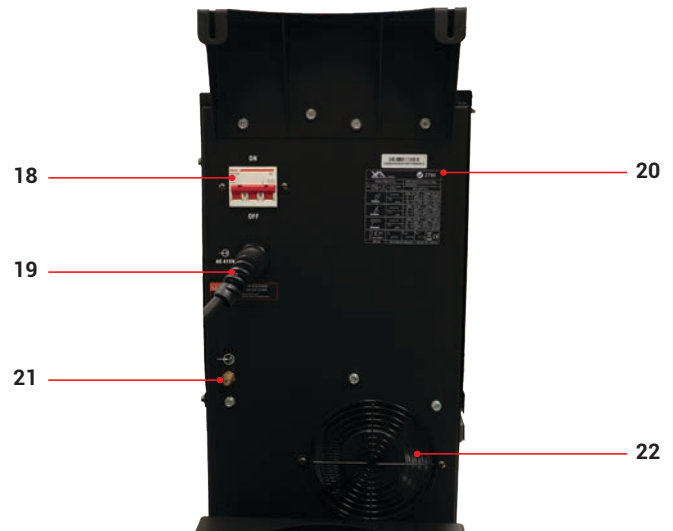

INTERNAL PANEL LAYOUT

23. Burn back control
24. Spool holder assembly
25. Wire feeder mechanism

INSTALLATION SET UP FOR MMA (STICK) WELDING

1. Turn the power source on and select the **MMA** function with the Tig/MMA/Mig selector switch.

2. Connection of Output Cables

Two sockets are available on this welding machine. For MMA welding the electrode holder is shown be connected to the positive socket, while the earth lead (work piece) is connected to the negative socket, this is known as DC+ polarity. However various electrodes require a different polarity for optimum results and careful attention should be paid to the polarity, refer to the electrode manufacturers information for the correct polarity.

DC+ Electrode connected to ⊕ output socket.

DC- Electrode connected to ⊖ output socket.

3. Set the welding current relevant to the electrode type and size being used as recommended by the electrode manufacturer.

- 1. Set Tig/MMA/Mig selector switch to MMA
- 2. Connect the electrode lead to ⊕



3. Connect the earth lead to ⊖



3) Set the welding current using the amperage control dial



4) Place the electrode into the electrode holder and clamp tight.



5) Strike the electrode against the work piece to create an arc and hold the electrode steady to maintain the arc



6) Hold the electrode slightly above the work piece to maintain the arc while travelling at an even speed to create and even weld deposition.



7) To finish the weld, break the arc by quickly snapping the electrode away from the work piece.

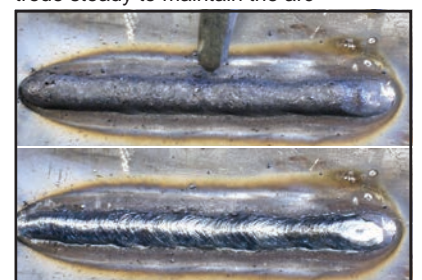

8) Wait for the weld to cool and carefully chip away the slag to reveal the weld metal below.

MMA(STICK) WELDING GUIDE



MMA (Manual Metal Arc) Welding

One of the most common types of arc welding is manual metal arc welding (MMA) or stick welding. An electric current is used to strike an arc between the base material and a consumable electrode rod or 'stick'. The electrode rod is made of a material that is compatible with the base material being welded and is covered with a flux that gives off gaseous vapours that serve as a shielding gas and providing a layer of slag, both of which protect the weld area from atmospheric contamination. The electrode core itself acts as filler material the residue from the flux that forms a slag covering over the weld metal must be chipped away after welding.

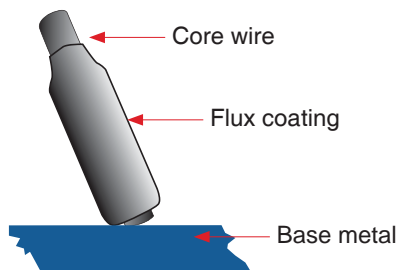
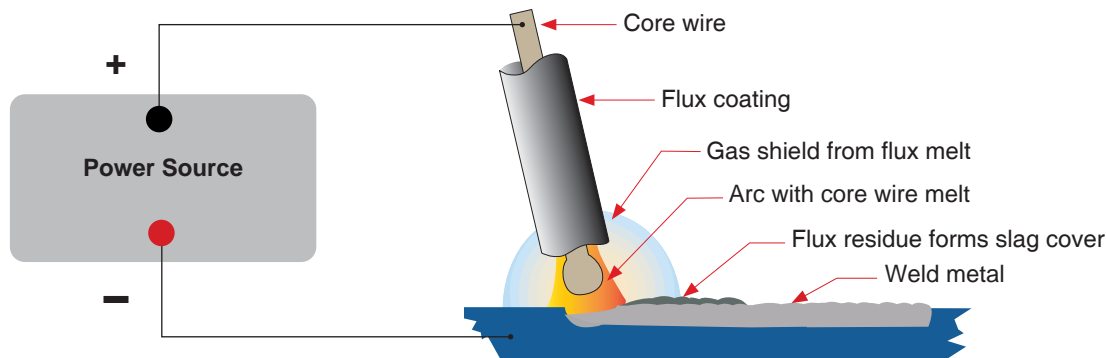

- The arc is initiated by momentarily touching the electrode to the base metal.
- The heat of the arc melts the surface of the base metal to form a molten pool at the end of the electrode.
- The melted electrode metal is transferred across the arc into the molten pool and becomes the deposited weld metal.
- The deposit is covered and protected by a slag which comes from the electrode coating.
- The arc and the immediate area are enveloped by an atmosphere of protective gas

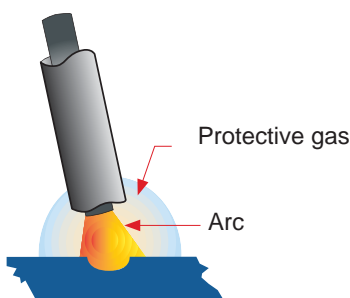

Manual metal arc (stick) electrodes have a solid metal wire core and a flux coating. These electrodes are identified by the wire diameter and by a series of letters and numbers. The letters and numbers identify the metal alloy and the intended use of the electrode.

The **Metal Wire Core** works as conductor of the current that maintains the arc. The core wire melts and is deposited into the welding pool.

The covering on a shielded metal arc welding electrode is called **Flux**. The flux on the electrode performs many different functions. These include:

- producing a protective gas around the weld area
- providing fluxing elements and deoxidizers
- creating a protective slag coating over the weld as it cools
- establishing arc characteristics
- adding alloying elements.

Covered electrodes serve many purposes in addition to adding filler metal to the molten pool. These additional functions are provided mainly by the covering on the electrode.

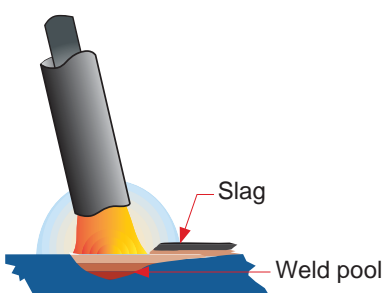

MMA (Stick) Welding Fundamentals

Electrode Selection

As a general rule, the selection of an electrode is straight forward, in that it is only a matter of selecting an electrode of similar composition to the parent metal. However, for some metals there is a choice of several electrodes, each of which has particular properties to suit specific classes of work. It is recommended to consult your welding supplier for the correct selection of electrode.

Electrode Size

Average Thickness of Material	Maximum Recommended Electrode Diameter
1.0 - 2.0mm	2.5mm
2.0 - 5.0mm	3.2mm
5.0 - 8.0mm	4.0mm
8.0 - > mm	5.0mm

The size of the electrode generally depends on the thickness of the section being welded, and the thicker the section the larger the electrode required. The table gives the maximum size of electrodes that may be used for various thicknesses of section based on using a general purpose type 6013 electrode.

Welding Current (Amperage)

Electrode Size ø mm	Current Range (Amps)
2.5mm	60 - 95
3.2mm	100 - 130
4.0mm	130 - 165
5.0mm	165 - 260

Correct current selection for a particular job is an important factor in arc welding. With the current set too low, difficulty is experienced in striking and maintaining a stable arc. The electrode tends to stick to the work, penetration is poor and beads with a distinct rounded profile will be deposited. Too high current is accompanied by overheating of the electrode resulting in undercut and burning through of the base metal and producing

excessive spatter. Normal current for a particular job may be considered as the maximum, which can be used without burning through the work, overheating the electrode or producing a rough spattered surface. The table shows current ranges generally recommended for a general purpose type 6013 electrode.

Arc Length

To strike the arc, the electrode should be gently scraped on the work until the arc is established. There is a simple rule for the proper arc length; it should be the shortest arc that gives a good surface to the weld. An arc too long reduces penetration, produces spatter and gives a rough surface finish to the weld. An excessively short arc will cause sticking of the electrode and result in poor quality welds. General rule of thumb for down hand welding is to have an arc length no greater than the diameter of the core wire.

Electrode Angle

The angle that the electrode makes with the work is important to ensure a smooth, even transfer of metal. When welding in down hand, fillet, horizontal or overhead the angle of the electrode is generally between 5 and 15 degrees towards the direction of travel. When vertical up welding the angle of the electrode should be between 80 and 90 degrees to the work piece.

Travel Speed

The electrode should be moved along in the direction of the joint being welded at a speed that will give the size of run required. At the same time, the electrode is fed downwards to keep the correct arc length at all times. Excessive travel speeds lead to poor fusion, lack of penetration etc, while too slow a rate of travel will frequently lead to arc instability, slag inclusions and poor mechanical properties.

Material and Joint Preparation

The material to be welded should be clean and free of any moisture, paint, oil, grease, mill scale, rust or any other material that will hinder the arc and contaminate the weld material. Joint preparation will depend on the method used include sawing, punching, shearing, machining, flame cutting and others. In all cases edges should be clean and free of any contaminants. The type of joint will be determined by the chosen application.

GAS INSTALLATION & SET UP - MIG



1. Select the MIG function with the Tig/MMA/Mig selector switch.
2. Select Standard using the Standard/Spool Gun selector switch.
3. Plug the welding torch into the Euro Mig torch connection socket on the front panel, and tighten it.
4. Insert the earth cable plug into the required polarity and tighten - negative for gas shielded wires positive for gas less wires. The weld power cable goes into the opposing negative or positive socket.
5. Connect Gas Line to Gas Regulator and connect the gas regulator to the Gas Cylinder.
6. Fit the correct type and size of drive rollers.V Groove for Hard Wires. U Groove for Aluminium. Knurled for Flux Cored
7. Place the Wire Spool onto the Spool Holder - Note: the spool retaining nut is Left Hand thread. Snip the wire from the spool being sure to hold the wire to prevent rapid uncoiling. Feed the wire into the wire feeder inlet guide tube through to the drive roller.
8. Carefully feed the wire over the drive roller into the outlet guide tube, feed through about 150mm into the torch receptacle. Check that the drive roller being used complies with the wire diameter, replace the roller if necessary.



6) Fit the correct type and size of drive rollers.V Groove for Hard Wires. U Groove for Aluminium. Knurled for Flux Cored



7) Place wire onto spool holder - (spool retaining nut is left hand thread) Feed the wire through the inlet guide tube into the drive roller.



8) Feed wire over the drive roller into the outlet guide tube, Push the wire through approx 150mm.

9. Align the wire into the groove of the drive roller and close down the top roller making sure the wire is in the groove of the bottom drive roller, lock the pressure arm into place. Apply a medium amount of pressure to the drive roller.
10. Remove the gas nozzle and contact tip from the torch neck,
11. Press and hold the inch button to feed the wire through to the torch neck, release the inch button when the wire exits the torch neck.
12. Fit the correct sized contact tip and feed the wire through it, screw the contact tip into the tip holder of the torch head and nip it up tightly.
13. Fit the gas nozzle to the torch head.
14. Carefully open the gas cylinder valve and set the flow rate to between 6-10 l/min.
15. Set the welding parameters using the wire feed and voltage control knobs.
16. Using the **Burn Back** control set the amount of wire to 'burn back' after you release the torch trigger. This prevents the wire becoming stuck in the weld pool when finishing the weld.



9) Close down the top roller bracket and clip the pressure arm into place. Apply a medium amount of pressure to the drive roller.

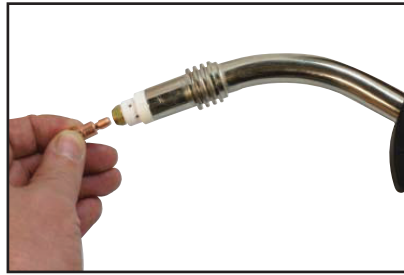

10) Remove the gas nozzle and contact tip from the front end of the mig torch.



11) Press and hold the inch wire button to feed the wire down the torch cable through to the torch head.



12) Fit the correct size contact tip over the wire and fasten tightly into the tip holder.



13) Fit the gas nozzle to the torch head.



14) Carefully open the valve of the gas cylinder, set the flow to 6-10 l/min



15) Set welding parameters using the voltage and wire feed controls.



16) Set Inductance control to desired arc characteristic. Hard for tight narrow arc and Soft for wider softer arc. Half way is a good beginning position for most wires.



17) Adjust the burn back control to prevent the wire sticking in the weld pool. Burn back control is located above the wire feed motor.

WIRE FEED ROLLER SELECTION



The importance of smooth consistent wire feeding during MIG welding cannot be emphasized enough. Simply put the smoother the wire feed then the better the welding will be. Feed rollers or drive rollers are used to feed the wire mechanically along the length of the welding gun. Feed rollers are designed to be used for certain types of welding wire and they have different types of grooves machined in them to accommodate the different types of wire. The wire is held in the groove by the top roller of the wire drive unit and is referred to as the pressure roller, pressure is applied by a tension arm that can be adjusted to increase or decrease the pressure as required. The type of wire will determine how much pressure can be applied and what type of drive roller is best suited to obtain optimum wire feed.

Solid Hard Wire - like Steel, Stainless Steel require a drive roller with a V shape groove for optimum grip and drive capability. Solid wires can have more tension applied to the wire from the top pressure roller that holds the wire in the groove and the V shape groove is more suited for this. Solid wires are more forgiving to feed due to their higher cross sectional column strength, they are stiffer and don't bend so easy.

Soft Wire - like Aluminium requires a U shape groove. Aluminium wire has a lot less column strength, can bend easily and is therefore more difficult to feed. Soft wires can easily buckle at the wire feeder where the wire is fed into inlet guide tube of the torch. The U-shaped roller offers more surface area grip and traction to help feed the softer wire. Softer wires also require less tension from the top pressure roller to avoid deforming the shape of the wire, too much tension will push the wire out of shape and cause it to catch in the contact tip.

Flux Core / Gasless Wire - these wires are made up of a thin metal sheath that has fluxing and metal compounds layered onto it and then rolled into a cylinder to form the finished wire. The wire cannot take too much pressure from the top roller as it can be crushed and deformed if too much pressure is applied. A knurled drive roller has been developed and it has small serrations in the groove, the serrations grip the wire and assist to drive it without too much pressure from the top roller. The down side to the knurled wire feed roller on flux cored wire is it will slowly over time bit by bit eat away at the surface of the welding wire, and these small pieces will eventually go down into the liner. This will cause clogging in the liner and added friction that will lead to welding wire feed problems. A U groove wire can also be used for flux core wire without the wire particles coming of the wire surface. However it is considered that the knurled roller will give a more positive feed of flux core wire without any deformation of the wire shape.

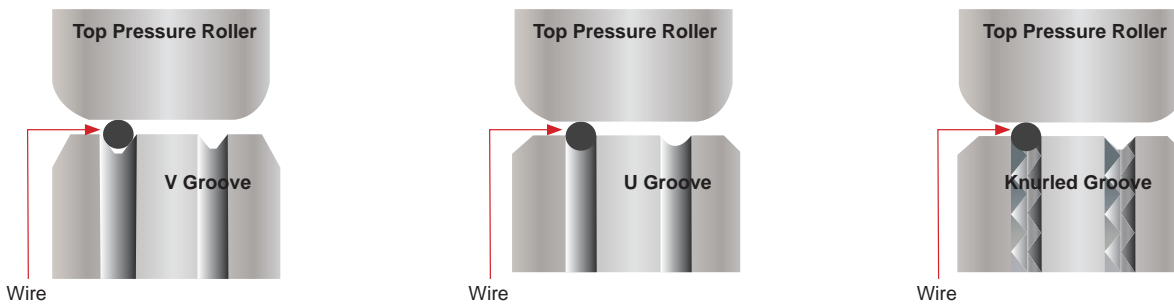

ROLLER DIAMETER: 30/22/10

MACHINE TYPE: MIG185V - MIG200RZ - MIG205SS - MIG250CRZ
 MIG250DRZ - MIG350WRZ - MIG350SWF - MIG500SWF (older model)



V Groove Drive Roller - Steel Wire

Part Number	Description
XA-DRV0608	XA Drive Roll V Groove 0.6-0.8mm - 30/22/10
XA-DRV0810	XA Drive Roll V Groove 0.8-1.0mm - 30/22/10
XA-DRV1012	XA Drive Roll V Groove 1.0-1.2mm - 30/22/10
XA-DRV1216	XA Drive Roll V Groove 1.2-1.6mm - 30/22/10

Knurled Drive Roller - Flux Core Wire

Part Number	Description
XA-DRK0809	XA Drive Roll Knurled 0.8-0.9mm - 30/22/10
XA-DRK0912	XA Drive Roll Knurled 0.9-1.2mm - 30/22/10
XA-DRK1216	XA Drive Roll Knurled 1.2-1.6mm - 30/22/10

U Groove Roller - Soft Wire

Part Number	Description
XA-DRU1012	XA Drive Roll U Groove 1.0-1.2mm - 30/22/10
XA-DRU1216	XA Drive Roll U Groove 1.2-1.6mm - 30/22/10

WIRE INSTALLATION AND SET UP GUIDE

Again the importance of smooth consistent wire feeding during MIG welding cannot be emphasized enough. The correct installation of the wire spool and the wire into the wire feed unit is critical to achieving an even and consistent wire feed. A high percentage of faults with mig welders emanate from poor set up of the wire into the wire feeder. The guide below will assist in the correct setup of your wire feeder.



(1) Remove the spool retaining nut.

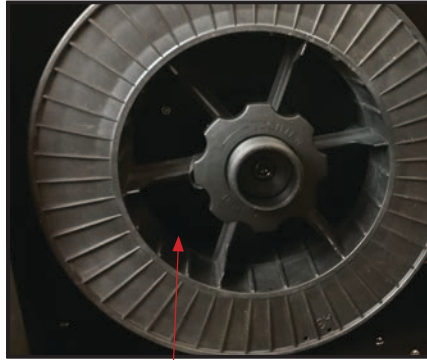

(2) Fit the wire spool onto the spool holder fitting the locating pin into the location hole on the spool. Replace the spool retaining nut tightly



(3) Snip the wire carefully, be sure to hold the wire to prevent the spool uncoiling.

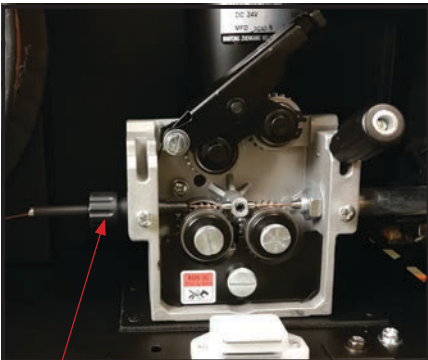

(4) Carefully feed the wire into the inlet guide tube of the wire feed unit.

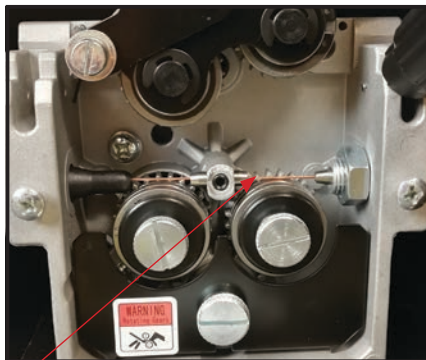

(5) Feed the wire through the drive roller and into the outlet guide tube of the wire feeder.

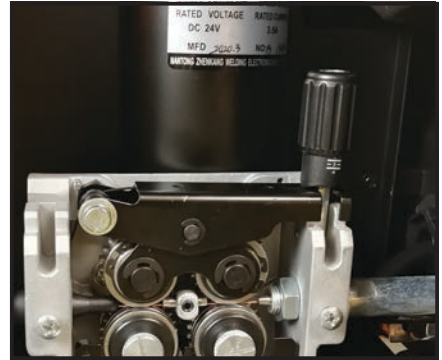

(6) Lock down the top pressure roller and apply a medium amount of pressure using the tension adjustment knob

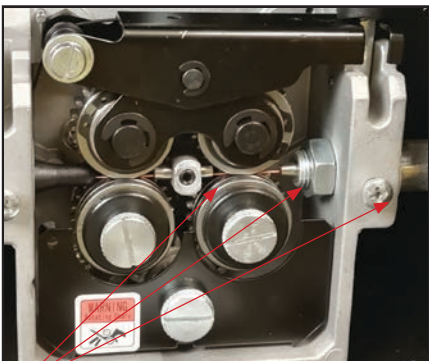

(7) Check that the wire passes through the centre of the outlet guide tube without touching the sides. Loosen the locking screw and then loosen the outlet guide tube retaining nut too make adjustment if required. Carefully retighten the locking nut and screw to hold the new position. adjust wire tensioner so that adequate pressure is supplied to wire so it does not slip



(8) The weight and speed of the wire spool turning creates an inertia that can cause the spool to run on and the wire loop over the side of the spool and tangle. if this happens increase the pressure on the tension spring inside the spool holder assembly using the tension adjustment screw.
NOTE: As wire volume reduces spool brake tension may also require re-adjustment



(9) A simple check for the correct drive tension is to bend the end of the wire over hold it about 100mm from your hand and let it run into your hand, it should coil round in your hand without stopping and slipping at the drive rollers, increase the tension if it slips.

MIG TORCH LINER INSTALLATION



1. Lay the torch out straight on the ground and remove the front end parts
2. Remove the liner retaining nut.
3. Carefully pull the liner out of the torch cable assembly
4. Select the correct new liner and carefully unravel avoiding putting any kinks in the liner, if you kink the liner it will make it no good and will require replacement.
5. Carefully and slowly feed the liner in short forward movements down the cable assembly all the way through and out the torch neck end. Avoid kinking the liner, kinking liner it will make it no good and require replacement.
6. Fit the liner retaining nut and screw down only 1/2 way
7. Leaving the torch straight snip the liner approximately 3mm past the end of the torch neck
8. Place the tip holder over the end of the liner and screw into the torch neck nipping it up tight.
9. Screw down the liner nut the remaining 1/2 and nip it up tight. This method compresses the liner inside the torch cable assembly preventing it moving during use and ensures good wire feed.



(1) Remove mig torch front end parts

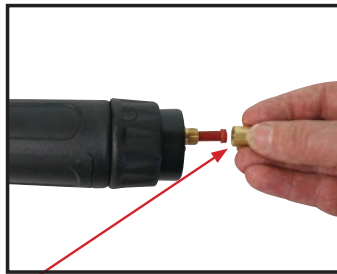

(2) Remove the liner retaining nut

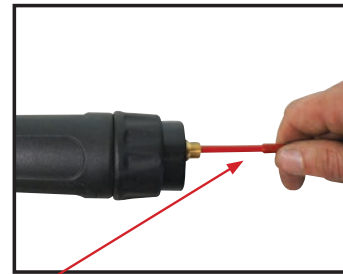

(3) Carefully pull out and completely remove the liner

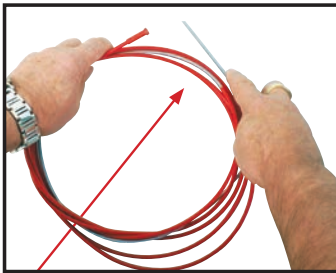

(4) Carefully unravel the new liner

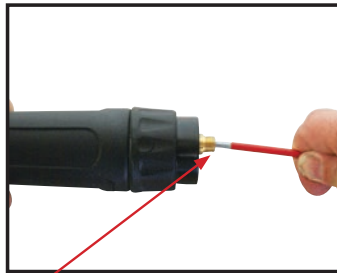

(5) Carefully feed in the new liner down the torch lead all the way to exit the torch neck.

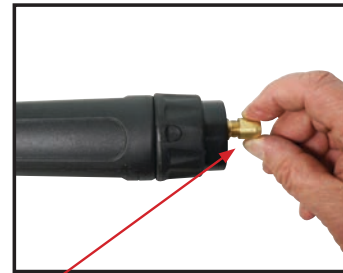

(6) Fit the liner retaining nut and screw only 1/2 way down

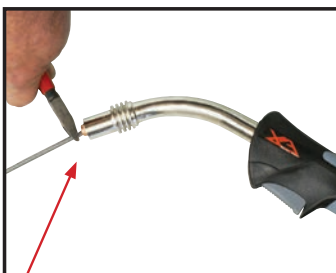

(7) Snip the liner off 3mm past the end of the torch neck.

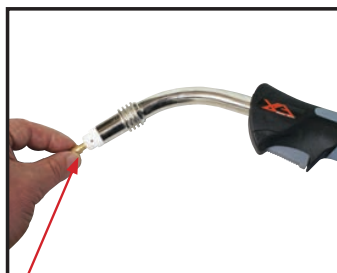

(8) Replace the front end parts



(9) Fully screw down the liner retaining nut and nip it up tight.

Mig Torch Liners

The liner is both one of the simplest and most important components of a MIG gun. Its sole purpose is to guide the welding wire from the wire feeder, through the gun cable and up to the contact tip.

Steel Liners

Most MIG gun liners are made from coiled steel wire also known as piano wire, which provides the liner with good rigidity and flexibility and allows it to guide the welding wire smoothly through the welding cable as it bends and flexes during operational use. Steel liners are primarily used for feeding of solid steel wires, other wires such as Aluminium, Silicon Bronze etc will perform better using a teflon or Polyamide liner. The internal diameter of the liner is important and relative to the wire diameter being used and will assist in smooth feeding and prevention of the wire kinking and birdnesting at the drive rollers. Also bending the cable too tightly during welding increases the friction between the liner and the welding wire making it more difficult to push the wire through the liner resulting in poor wire feeding, premature liner wear and birdnesting. Dust, grime and metal particles can accumulate inside the liner over time and cause friction and blockages, it is recommended to periodically blow out the liner with compressed air.

Small diameter welding wires, 0.6mm through 1.0mm have relatively low columnar strength, and if matched with an oversized liner, can cause the wire to wander or drift within the liner. This in turn leads to poor wire feeding and premature liner failure due to excessive wear. By contrast, larger diameter welding wires, 1.2mm through 2.4mm have much higher columnar strength but it is important to make sure the liner has enough internal diameter clearance. Most manufacturers will produce liners sized to match wire diameters and length of welding torch cable and most are colour coded to suit.



Teflon and Polyamide (PA) Liners

Teflon liners are well suited for feeding soft wires with poor column strength like aluminium wires. The interiors of these liners are smooth and provide stable feedability, especially on small diameter welding wire Teflon can be good for higher heat applications that utilize water-cooled torches and brass neck liners. Teflon has good abrasion resistance characteristics and can be used with a variety of wire types such as silicon bronze, stainless steel as well as aluminium. A note of caution to carefully inspect the end of the welding wire prior to feeding it down the liner. Sharp edges and burrs can score the inside of the liner and lead to blockages and accelerated wear.

Polyamide Liners (PA) are made of carbon infused nylon and are ideal for softer aluminum, copper alloy welding wires and push pull torch applications. These liners are generally fitted with a floating collet to allow the liner to be inserted all the way to the feed rollers.

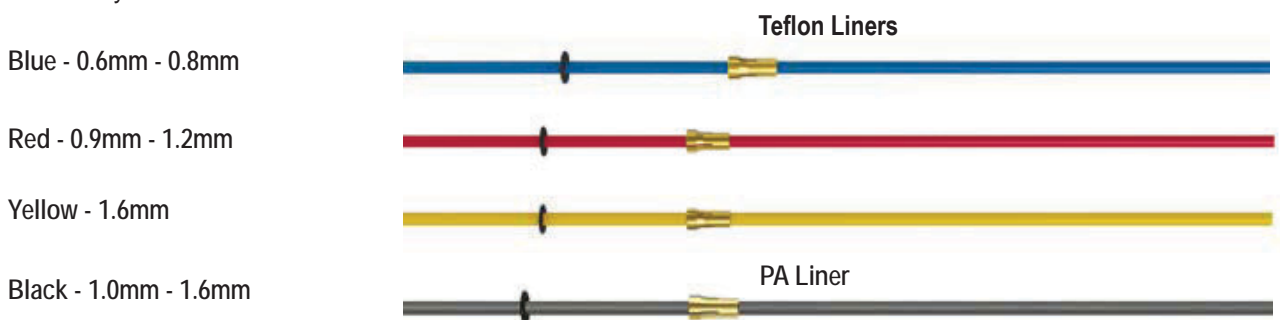

Copper - Brass Neck Liners

For high heat applications fitting brass or copper wound jumper or neck liner on the end of the liner at the neck end will increase the working temperature of the liner as well as improve the electrical conductivity of the welding power transfer to the wire.



TORCH & WIRE FEED SET UP FOR ALUMINIUM WIRE



1. Lay the torch out straight on the ground and remove the front end parts
2. Remove the liner retaining nut.
3. Carefully pull the liner out of the torch cable assembly
4. Select a Polymide or liner, carefully and slowly feed the liner in short forward movements down the cable assembly all the way through and out the torch neck end. Avoid kinking the liner, kinking the liner will ruin it and require replacement. Leave the liner extending out the end of the torch neck end by 3mm.
5. Fit the liner retaining nut together with the liner o-ring.
6. Replace the front end parts
7. Fit the liner collet, liner O-ring and liner retaining nut.
8. Push the liner firmly into the torch lead and tighten the liner retaining nut.
9. Install a U groove drive roller of the correct size to match the wire diameter being used.

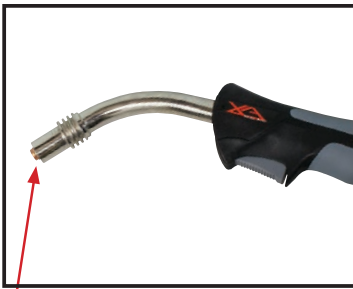

(1) Remove mig torch front end parts

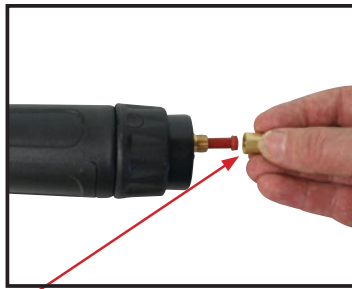

(2) Remove the liner retaining nut

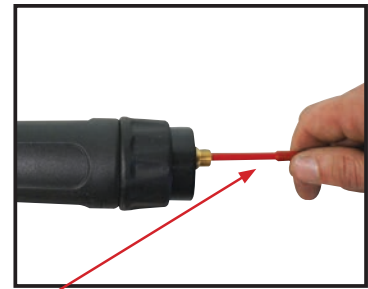

(3) Carefully pull out and completely remove the liner

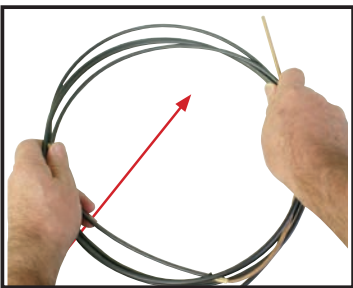

(4) Carefully unravel the new liner

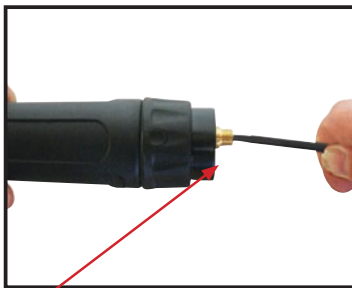

(5) Carefully feed in the new liner in short forward movements down the torch lead all the way to exit the torch neck. Be careful not to kink the liner



(6) Replace the front end parts

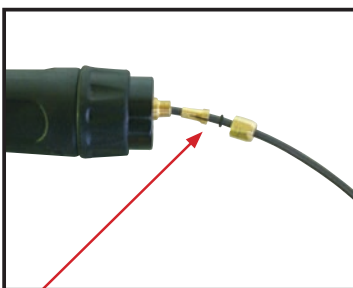

(7) Fit the liner collet, liner O-ring and liner retaining nut.

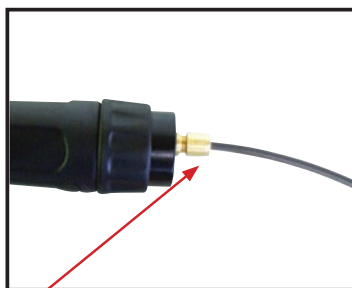

(8) Push the liner firmly into the torch lead and tighten the liner retaining nut

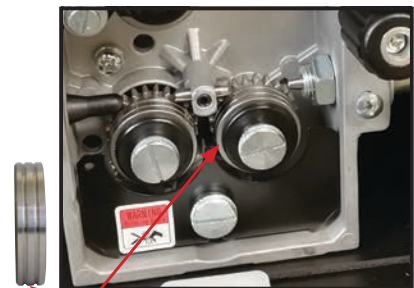

(9) Install a U groove drive roller of the correct size for the diameter wire being used.

TORCH & WIRE FEED SET UP FOR ALUMINIUM WIRE

10. Loosen off the inlet guide tube retaining screw.
11. Remove the inlet guide tube from the front end machine euro connector using long nose pliers.
12. Carefully feed the extended Polymide liner section into the inlet guide tube hole of the machine euroconnector.
13. Feed the extended Polymide liner all the way up and over the drive roller.
14. Tighten the torch euro connection to the machine euro connector.
15. Cut the extended liner with a sharp Stanley knife just in front of the drive roller.
16. Fit an Aluminium contact tip of the correct size to match the diameter of the wire being used.
17. Fit the remaining front end parts to the torch neck ready for welding.

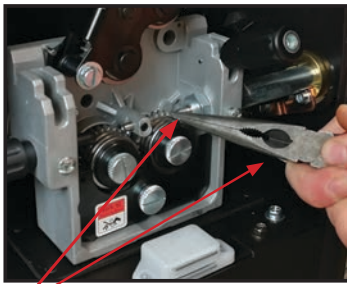

(10) Push the inlet guide tube forward with a pair of long nose pliers.

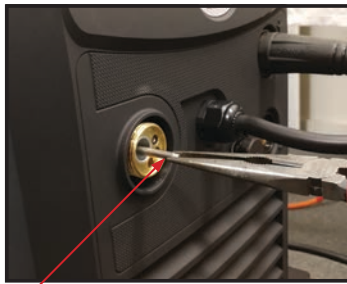

(11) Remove the inlet guide tube using long nose pliers.

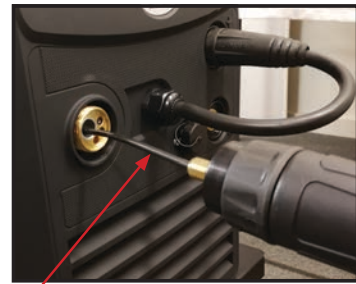

(12) Carefully feed the Polymide liner into the inlet guide tube hole of the torch euro receptacle



(13) Take the extended Polymide liner all the way up and over the drive roller



(14) Tighten and secure the torch euro connector to the machine euro receptacle

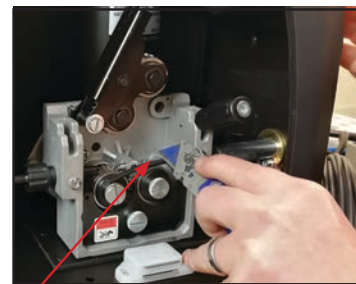

(15) Cut the extended liner with a sharp Stanley knife just in front of the drive roller,

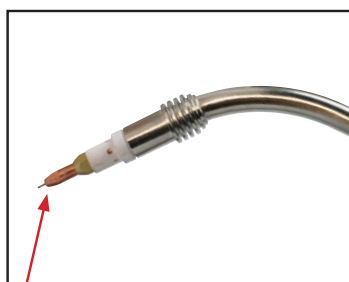

(16) Fit an Aluminium contact tip of the correct size to match the wire diameter being used

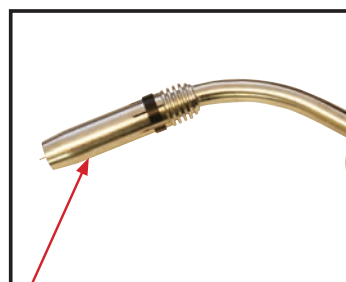

(17) Fit the remaining front end parts to the torch neck ready for welding.

MIG (Metal Inert Gas) Welding

Definition of MIG Welding - MIG (metal inert gas) welding also known as GMAW (gas metal arc welding) or MAG (metal active gas welding), is a semi-automatic or automatic arc welding process in which a continuous and consumable wire electrode and a shielding gas are fed through a welding gun. A constant voltage, direct current power source is most commonly used with MIG welding. There are four primary methods of metal transfer in MIG welding, called short circuit (also known as dip transfer) globular transfer, spray transfer and pulsed-spray, each of which has distinct properties and corresponding advantages and limitations. To perform MIG welding, the basic necessary equipment is a welding gun, a wire feed unit, a welding power supply, an electrode wire, and a shielding gas supply. Short circuit transfer is the most common used method whereby the wire electrode is fed continuously down the welding torch through to and exiting the contact tip. The wire touches the work piece and causes a short circuit the wire heats up and begins to form a molten bead, the bead separates from the end of the wire and forms a droplet that is transferred into the weld pool. This process is repeated about 100 times per second, making the arc appear constant to the human eye.

MIG Circuit Diagram

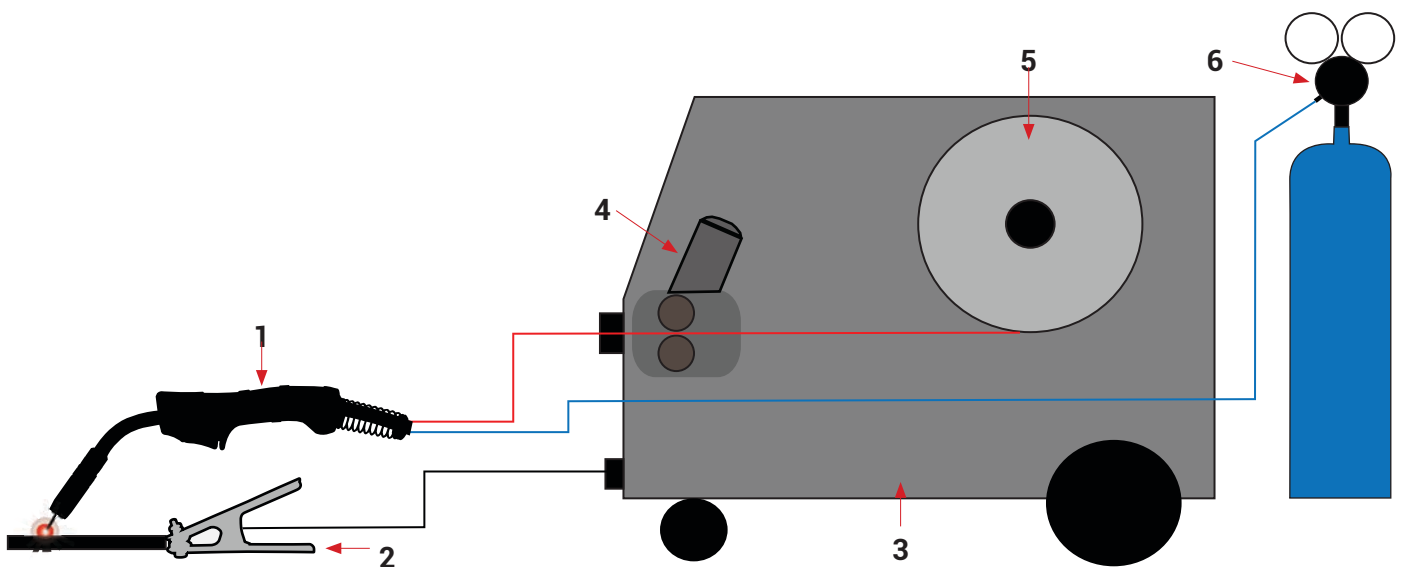

1. MIG Torch - 2. Work Piece - 3. Power Source - 4. Wire Feeder - 5. Wire Spool - 6. Gas

IMPORTANT! - We strongly recommend that you check for gas leaks prior to operation of your machine. We recommend that you close the cylinder valve when the machine is not in use.

Esseti NZ Ltd, authorised representatives or agents of Esseti NZ Ltd will not be liable or responsible for the loss of any gas.

MIG (Metal Inert Gas) Welding

Short Circuit Transfer - Short circuit transfer is the most common used method whereby the wire electrode is fed continuously down the welding torch through to and exiting the contact tip. The wire touches the work piece and causes a short circuit the wire heats up and begins to form a molten bead, the bead separates from the end of the wire and forms a droplet that is transferred into the weld pool. This process is repeated about 100 times per second, making the arc appear constant to the human eye.

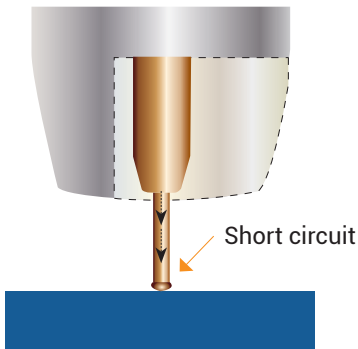

The wire approaches the work piece and touches the work creating a short circuit between the wire and the base metal, because there is no space between the wire and the base metal there is no arc and current flows through the wire.

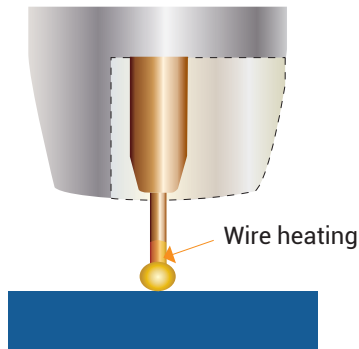

The wire cannot support all the current flow, resistance builds up and the wire becomes hot and weak and begins to melt

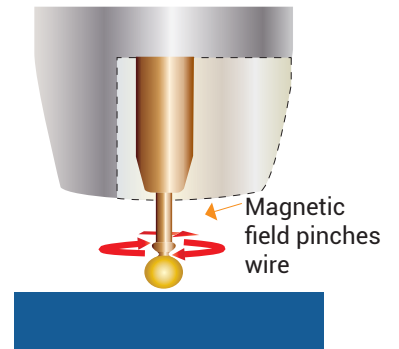

The current flow creates a magnetic field that begins to pinch the melting wire forming it into droplet

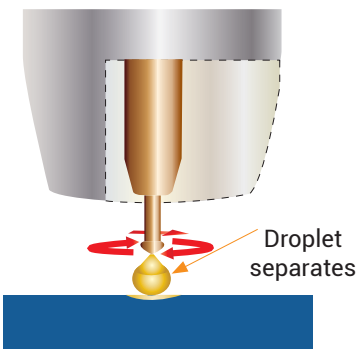

The pinch causes the forming droplet to separate and fall towards the now creating weld pool.

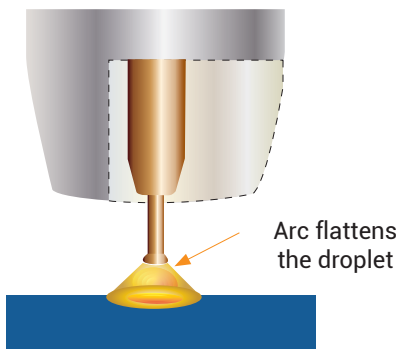

An arc is created at the separation of the droplet and the heat and force of the arc flattens out the droplet into the weld pool. The heat of the arc melts the end of the wire slightly as it feeds towards the base metal

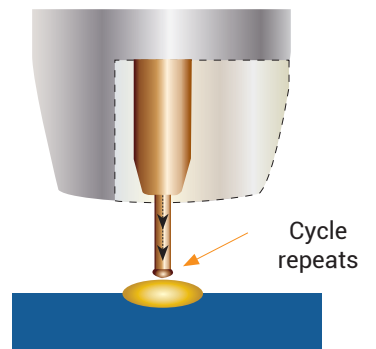

The wire feed speed overcomes the heat of the arc and the wire again approaches the work to short circuit and repeat the cycle.

Basic MIG Welding

Good weld quality and weld profile depends on gun angle, direction of travel, electrode extension (stick out), travel speed, thickness of base metal, wire feed speed (amperage) and arc voltage. To follow are some basic guides to assist with your setup.

Gun Position - Travel Direction, Work Angle

Gun position or technique usually refers to how the wire is directed at the base metal, the angle and travel direction chosen. Travel speed and work angle will determine the characteristic of the weld bead profile and degree of weld penetration.

Push Technique

The wire is located at the leading edge of the weld pool and pushed towards the un-melted work surface. This technique offers a better view of the weld joint and direction of the wire into the weld joint. Push technique directs the heat away from the weld puddle allowing faster travel speeds providing a flatter weld profile with light penetration - useful for welding thin materials. The welds are wider and flatter allowing for minimal clean up / grinding time.

Perpendicular Technique

The wire is fed directly into the weld, this technique is used primarily for automated situations or when conditions make it necessary. The weld profile is generally higher and a deeper penetration is achieved.

Drag Technique

The gun and wire is dragged away from the weld bead. The arc and heat is concentrated on the weld pool, the base metal receives more heat, deeper melting, more penetration and the weld profile is higher with more build up.

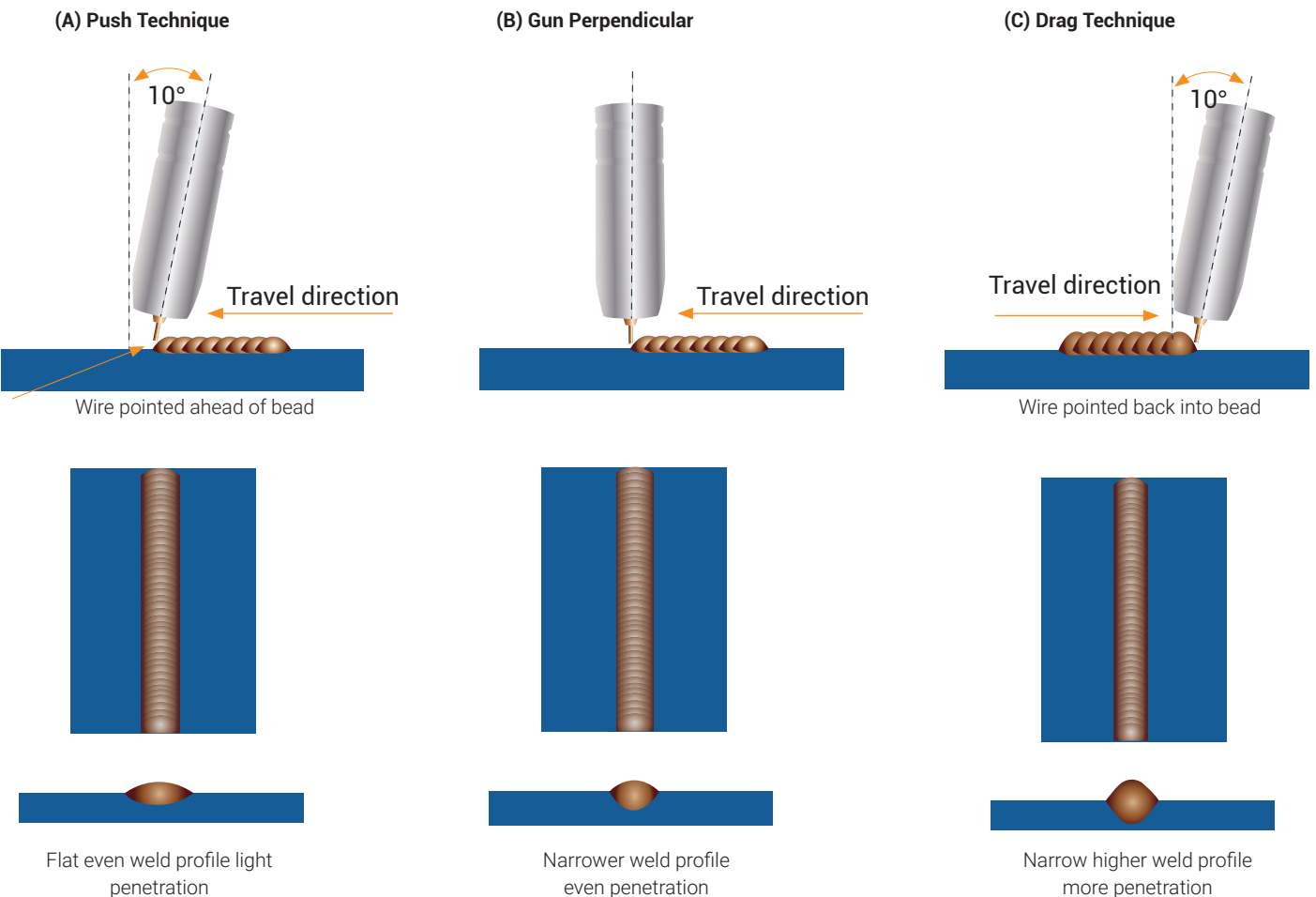

Travel Angle

Travel angle is the right to left angle relative to the direction of welding. A travel angle of 5°- 15° is ideal and produces a good level of control over the weld pool. A travel angle greater than 20° will give an unstable arc condition with poor weld metal transfer, less penetration, high levels of spatter, poor gas shield and poor quality finished weld.

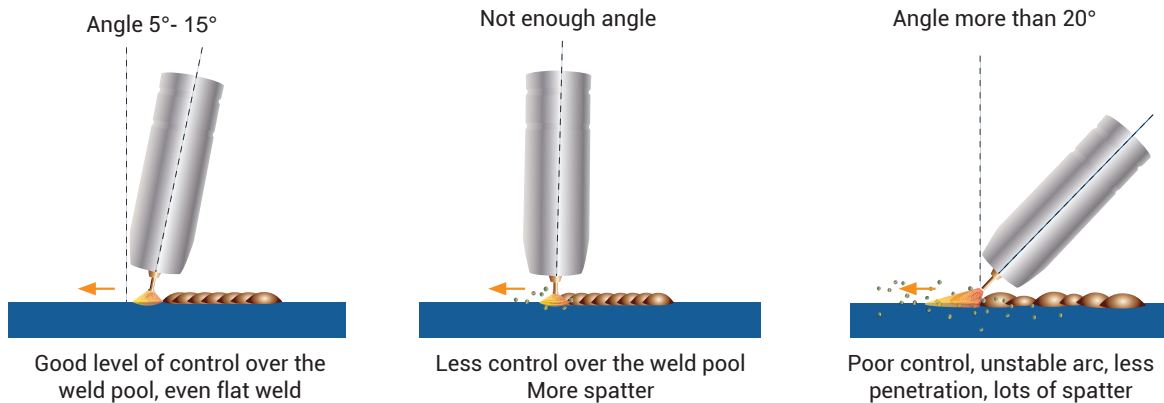

Angle to Work

The work angle is the forward back angle of the gun relative to the work piece.

The correct work angle provides good bead shape, prevents undercut, uneven penetration, poor gas shield and poor quality finished weld.

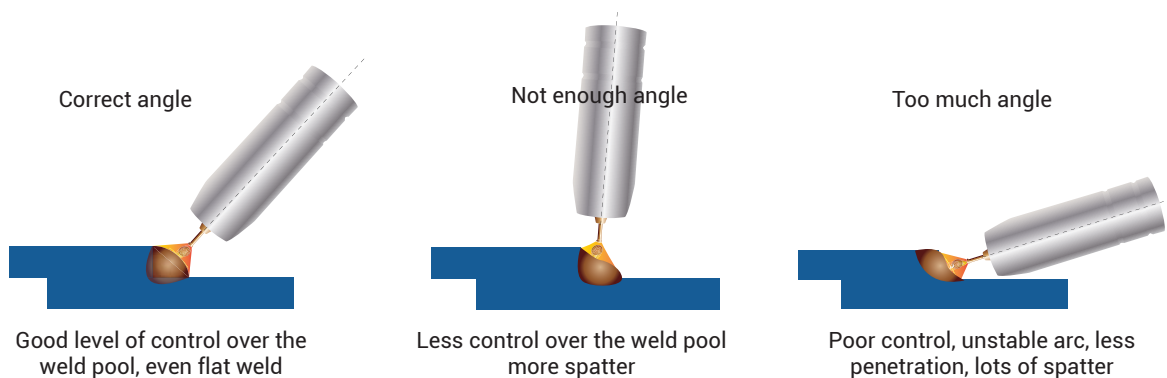

Stick Out

Stick out is the length of the unmelted wire protruding from the end of the contact tip.

A constant even stick out of 5-10mm will produce a stable arc, and an even current flow providing good penetration and even fusion. Too short stick out will cause an unstable weld pool, produce spatter and over heat the contact tip. Too long stick out will cause an unstable arc, lack of penetration, lack of fusion and increase spatter.

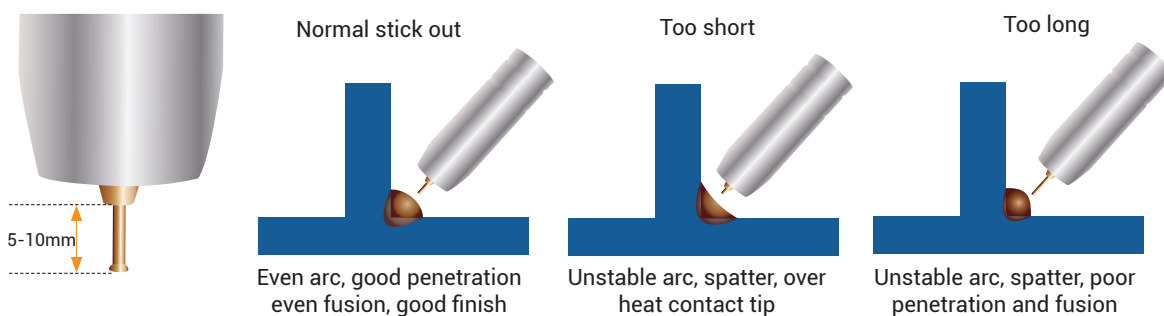

Travel Speed

Travel speed is the rate that the gun is moved along the weld joint and is usually measured in mm per minute. Travel speeds can vary depending on conditions and the welders skill and is limited to the welders ability to control the weld pool. Push technique allows faster travel speeds than Drag technique. Gas flow must also correspond with the travel speed, increasing with faster travel speed and decreasing with slower speed. Travel speed needs to match the amperage and will decrease as the material thickness and amperage increase.

Too Fast Travel Speed

A too fast travel speed produces too little heat per mm of travel resulting in less penetration and reduced weld fusion, the weld bead solidifies very quickly trapping gases inside the weld metal causing porosity. Undercutting of the base metal can also occur and an unfilled groove in the base metal is created when the travel speed is too fast to allow molten metal to flow into the weld crater created by the arc heat.

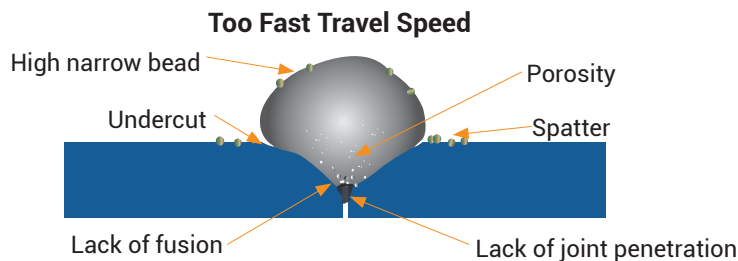

Too Slow Travel Speed

A too slow travel speed produces a large weld with lack of penetration and fusion. The energy from the arc dwells on top of the weld pool rather than penetrating the base metal. This produces a wider weld bead with more deposited weld metal per mm than is required resulting in a weld deposit of poor quality.

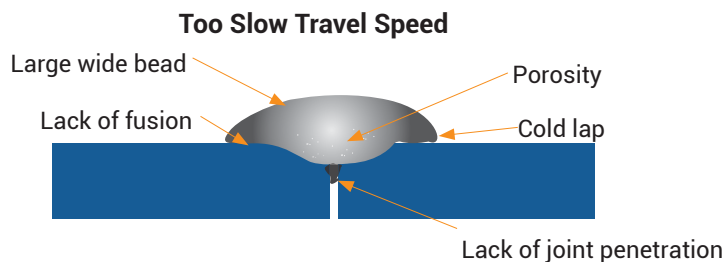

Correct Travel Speed

The correct travel speed keeps the arc at the leading edge of the weld pool allowing the base metal to melt sufficiently to create good penetration, fusion and wetting out of the weld pool producing a weld deposit of good quality.

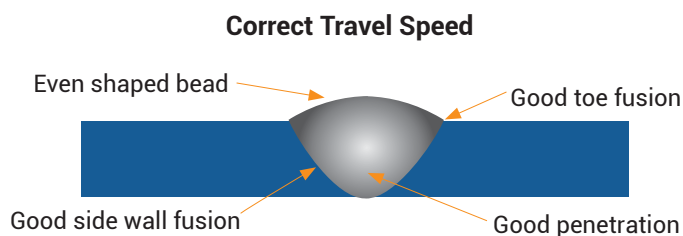

Wire types and sizes

Use the correct wire type for the base metal being welded. Use stainless steel wire for stainless steel, aluminium wires for aluminium and steel wires for steel.

Use a smaller diameter wire for thin base metals. For thicker materials use a larger wire diameter and larger machine, check the recommended welding capability of you machine.

As a guide refer to the "Welding Wire Thickness Chart" below.

WELDING WIRE DIAMETER CHART							
MATERIAL THICKNESS	RECOMMENDED WIRE DIAMETERS						
	MIG SOLID WIRE				GASLESS FLUX CORED WIRE		
	0.6mm	0.8mm	0.9mm	1.0mm	0.8mm	0.9mm	1.2mm
24 Gauge (.60mm)							
22 Gauge (.75mm)							
20 Gauge (.90mm)							
18 Gauge (1.0mm)							
16 Gauge (1.2mm)							
14 Gauge (1.9mm)							
3.0mm							
5.0mm							
6.0mm							
8.0mm							
10.0mm							
12.0mm							

For material thickness of 5.0mm and greater, multi-pass runs or a beveled joint design may be required depending on the amperage capability of your machine.

Gas selection

The purpose of the gas in the MIG process is to protect / shield the wire, the arc and the molten weld metal from the atmosphere. Most metals when heated to a molten state will react with the air in the atmosphere, without the protection of the shielding gas the weld produced would contain defects like porosity, lack of fusion and slag inclusions. Additionally some of the gas becomes ionised (electrically charged) and helps the current flow smoothly.

The correct gas flow is also very important in protecting the welding zone from the atmosphere.

Too low flow will give inadequate coverage and result in weld defects and unstable arc conditions.

Too high flow can cause air to be drawn into the gas column and contaminate the weld zone.

Use the correct shielding gas. Co2 is good for steel and offers good penetration characteristics, the weld profile is narrower and slightly more raised than the weld profile obtained from Argon Co2 mixed gas. Argon Co2 mix gas offers better weld ability for thin metals and has a wider range of setting tolerance on the machine. Argon 80% Co2 20% is a good all round mix suitable for most applications.

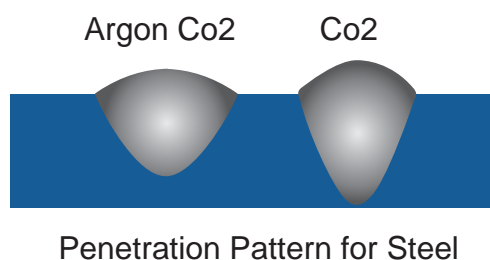

INSTALLATION SET UP OF THE SPOOL GUN



1. Switch on the machine, select the **MIG** function with the Tig/MMA/Mig selector switch.
2. Select **Spool Gun** using the Standard/Spool Gun selector switch.
3. Connect the Spool Gun to the Euro Mig torch connection socket on the front panel, and tighten it. Connect the Spool Gun control cable to the receptacle and tighten it.
4. Insert the earth cable plug into the **Negative** socket on the front of the machine and tighten it.
5. Connect **Gas Line** to **Gas Regulator** and connect the gas regulator to the **Gas Cylinder**.
6. Connect the Weld power cable to the **Positive** socket.
7. Take the Spool Gun and push the **Cover Release Button** to unlock the wire feed / spool cover.
8. Place the **Wire Spool** onto the **Spool Holder** - Note: the spool retaining nut is Left Hand thread. Hold and snip the wire from the spool being sure to hold the wire to prevent rapid uncoiling.



1. Set Tig/MMA/Mig selector switch to **MIG**

2. Set Standard/Spoolgun selector switch to **Spool Gun**

3. Connect Spool Gun control cable and Euro connector

5. Connect the gas line to the regulator and connect to the gas cylinder

6. Connect power lead to (+)

4. Connect earth lead to (-)



6) Connect weld power lead to (+)
Connect earth lead to (-)

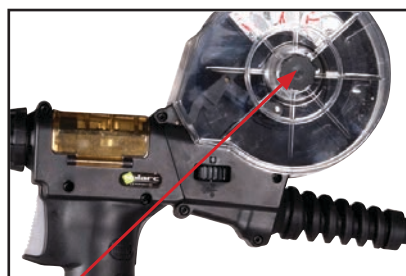

7) Push the cover release button to unlock the wire feed / spool cover.

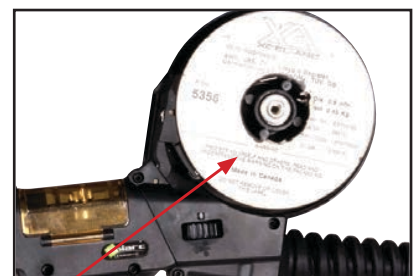

8) Place a spool of wire onto the Spool holder. Note: the spool retaining nut is Left Hand thread, turn it clockwise to undo it.

INSTALLATION SET UP OF THE SPOOL GUN

- (9) Connect weld power lead to \oplus
- (10) Take the Spool Gun and push the **Cover Release Button** to unlock the wire feed / spool cover.
- (11) Place the **Wire Spool** onto the **Spool Holder** - Note: the spool retaining nut is Left Hand thread. Hold and snip the wire from the spool being sure to hold the wire to prevent rapid uncoiling.
- (12) Unclip and swing open the wire feed housing cover to expose the wire feed mechanism.
- (13) Unclip and swing back the wire tension swing arm. Check the that the correct drive roller is installed.
- (14) Carefully feed the wire through the drive roller into the inlet guide tube. Swing back and clip down the wire tension swing arm.
- (15) Remove the gas nozzle and contact tip from the torch neck, Pull the trigger to drive the wire through the neck until it exits the contact tip holder.
- (16) Check the drive roll pressure is enough to drive the wire smoothly and djust the drive roll pressure if required by using the adjustment grub screw. Screw clockwise to increase the tension using an Allen Key tool.
- (17) Fit the correct sized contact tip and gas nozzle. Close the wire feed housing cover, fit the spool cover,ready for welding.
- (18) Carefully open the gas cylinder valve and set the flow rate to between 12-15 l/min.
- (19) Set the welding parameters using the wire feed and voltage control knobs.

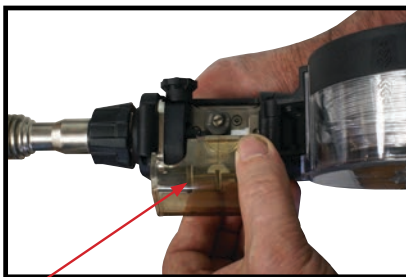

(12) Unclip and open the wire feed housing cover

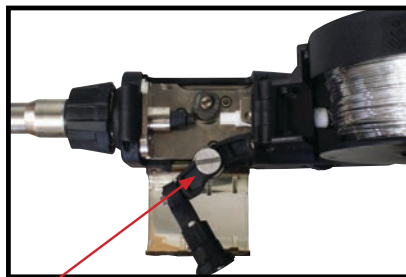

(13) Unclip and swing back the wire tension swing arm. Check the that the correct drive roller is installed.

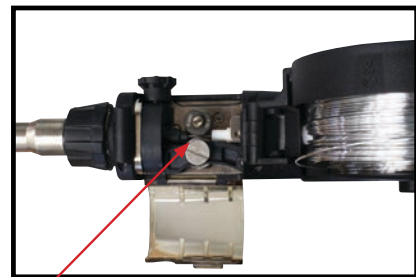

(14) Feed the wire through the drive roller into the inlet guide tube. Swing back and clip down the wire tension swing arm.

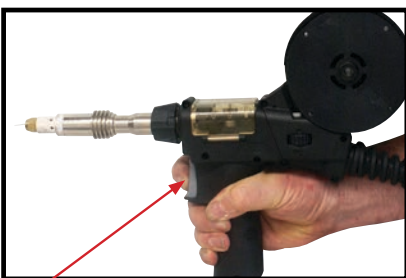

(15) Remove the gas nozzle and contact tip. Pull the trigger to drive the wire through the neck until it exits the contact tip holder

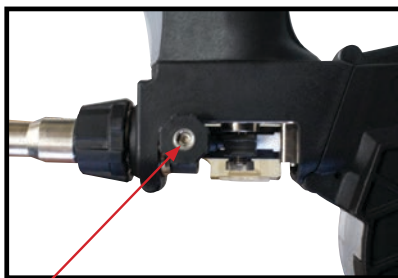

(16) Adjust the drive roll pressure if required by using the adjustment grub screw. Screw clockwise to increase the tension using an Allen Key tool.

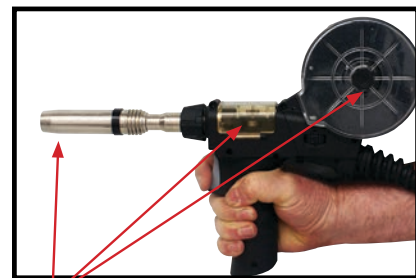

(17) Fit the contact tip and gas nozzle, close the wire feed housing cover, fit the spool cover,ready for welding.



(18) Carefully open the valve of the gas cylinder, set the flow to 12-15 l/min



(19) Set welding parameters using the voltage and wire feed controls.

SET UP INSTALLATION FOR PUSH PULL GUN



- (1) Select the **MIG** function with the MMA/MIG/TIG selector switch.
- (2) Select **Push-Pull** using the Standard, Push-pull/Spool Gun selector switch.
- (3) Plug the welding torch into the Euro Mig torch connection socket on the front panel, and tighten it. Connect the push pull torch control cable plug into the receptacle on the front panel of the wire feeder.
- (4) Connect **Gas Line** to **Gas Regulator** and connect the gas regulator to the **Gas Cylinder**.
- (5) Insert the earth cable plug into the **Negative** socket on the front of the machine and tighten it. Connect the Weld power cable to the **Positive** socket.
- (6) Fit the correct type and size drive rollers to the wire feed drive unit
- (7) Place the **Wire Spool** onto the **Spool Holder**. Feed the wire into the wire feeder inlet guide tube through to the drive rollers.
- (8) Carefully feed the wire over the drive rollers into the outlet guide tube, feed about 150mm into the torch receptacle.

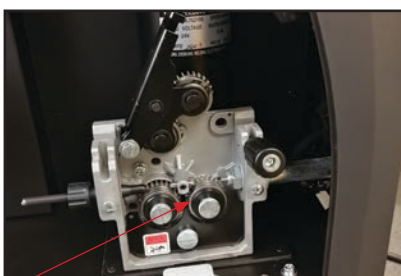

(6) Fit the correct type and size of drive rollers. V Groove for Hard Wires. Knurled for Flux Cored. U Groove for Aluminium.



(7) Place wire onto spool holder. Feed the wire through the inlet guide tube into the drive roller.

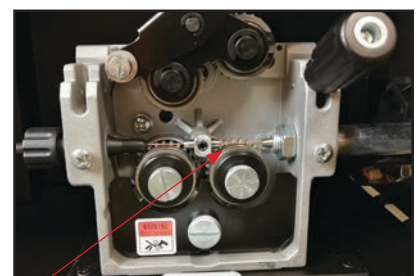

(8) Feed wire over the drive rollers into the outlet guide tube, Push the wire through approx 150mm.

SET UP INSTALLATION FOR PUSH PULL GUN

- (9) Unclip and swing open the wire feed housing cover to expose the wire feed mechanism.
- (10) Unclip and open out the wire tension swing arm. Check that the correct drive roller is installed.
- (11) Carefully feed the wire through the drive roller into the inlet guide tube. Swing back and clip down the wire tension arm.
- (12) Remove the gas nozzle and contact tip from the torch neck. Lay the torch cable straight or in a gentle curve on the floor (the wire will not feed if there are bends or kinks in the cable). Use the inch button to feed the wire down the cable into the torch drive unit. Release the inch button when the wire reaches the torch drive unit.
- (13) Use the torch switch to control the motor and carefully drive the wire through the drive unit into neck, swing back and clamp down the tension arm
- (14) Fit the correct sized contact tip and gas nozzle. Close the wire feed housing cover, fit the spool cover, ready for welding.
- (15) Carefully open the gas cylinder valve and set the flow rate to between 12-15 l/min.
- (16) Set the welding parameters using the wire feed and voltage control knobs.
- (17) Adjustment of the wire feed can be made remotely & during welding using the potentiometer on the torch body.

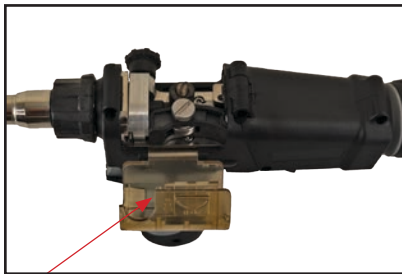

(9) Unclip and open the wire feed housing cover

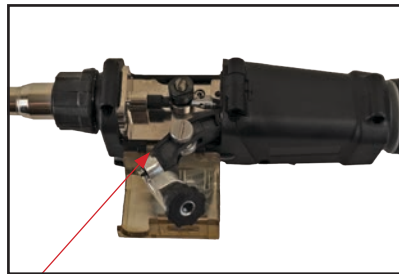

(10) Unclip and swing back the wire tension swing arm. Check that the correct drive roller is installed.



(11) Lay the torch cable straight or in a gentle curve on the floor. Use the inch button to feed the wire down the cable into the torch drive unit. Release the inch button when the wire reaches the torch drive unit.

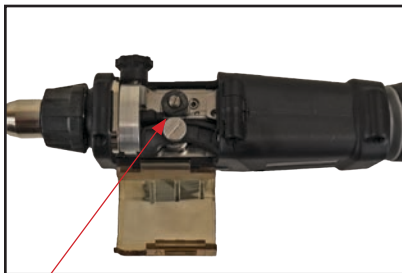

(12) Use the torch switch to drive the motor and carefully feed the wire through the drive rollers into the neck, swing back and clamp down the tension arm

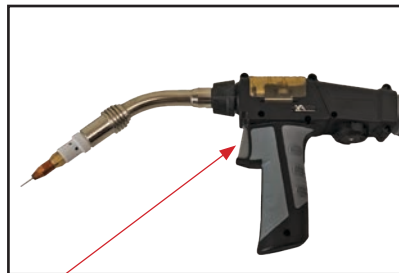

(13) Use the torch switch to feed the wire through the neck out to the end. Fit the correct size and type of contact tip.



(14) Fit the gas nozzle, close the wire feed housing cover ready for welding.

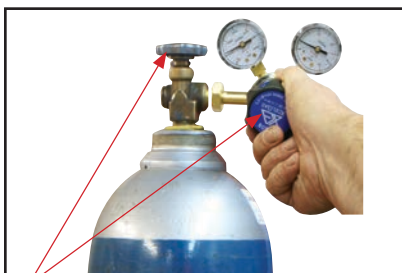

(15) Carefully open the valve of the gas cylinder, set the flow to 12-15 l/min



(16) Set welding parameters using the voltage and wire feed controls.

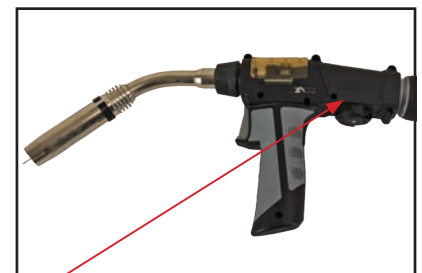

(17) Fine adjustment of the wire feed can be made remotely and during welding using the potentiometer located on the torch body

INSTALLATION SET UP FOR DC TIG WELDING



1. Switch on the machine, select the TIG function with the TIG/MMA/Mig selector switch.
2. Insert the power cable plug of the Tig torch into the Negative socket on the front of the machine and tighten it.
3. Insert the earth cable plug into the Positive socket on the front of the machine and tighten it.
4. Connect the gas line of the Tig torch to regulator and connect the regulator to the gas cylinder.



Lift Arc ignition allows the arc to be started easily in DC TIG by simply touching the tungsten to the work piece and lifting it up to start the arc. This prevents the tungsten tip sticking to the work piece and breaking the tip from the tungsten electrode. There is a particular technique called "rocking the cup" used in the Lift Arc process that provides easy use of the Lift Arc function.

8. Make sure the front end parts of the tig torch are correctly assembled, use the correct size and type of tungsten electrode for the job, the tungsten electrode requires a sharpened point for DC welding.
9. Turn on the Gas Valve located on the tig torch handle.
10. Lay the outside edge of the Gas Cup on the work piece with the Tungsten Electrode 1- 2mm from the work piece.
11. With a small movement rotate the Gas Cup forward so that the Tungsten Electrode touches the work piece.
12. Now rotate the Gas Cup in the reverse direction to lift the Tungsten electrode from the work piece to create the arc.



5) Assemble front end parts of the TIG torch



6) Carefully open the valve of the gas cylinder, set the flow to 6-10 l/min.



7) Set the welding current using the amperage control dial.



8) Assemble front end parts of the TIG torch, fitting a sharpened tungsten suitable for DC welding.

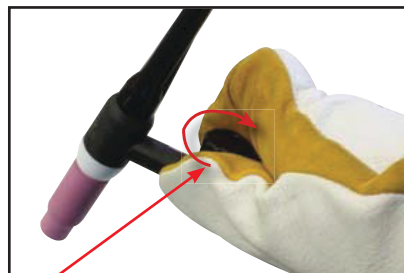

9) Turn on the Gas Valve.



10) Lay the outside edge of the Gas Cup on the work piece with the Tungsten Electrode 1- 2mm from the work piece.

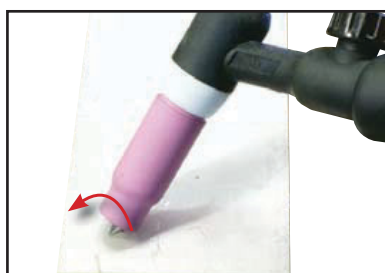

11) With a small movement rotate the Gas Cup forward so that the Tungsten Electrode touches the work piece.

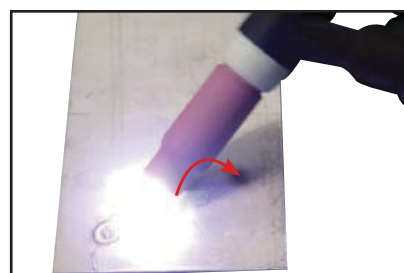

12) Now rotate the Gas Cup in the reverse direction to lift the Tungsten electrode from the work piece to create the arc.

DC TIG Welding

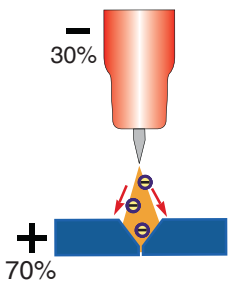

The DC power source uses what is known as DC (direct current) in which the main electrical component known as electrons flow in only one direction from the negative pole (terminal) to the positive pole (terminal). In the DC electrical circuit there is an electrical principle at work which should always be taken into account when using any DC circuit. With a DC circuit 70% of the energy (heat) is always on the positive side. This needs to be understood because it determines what terminal the TIG torch will be connected to (this rule applies to all the other forms of DC welding as well).

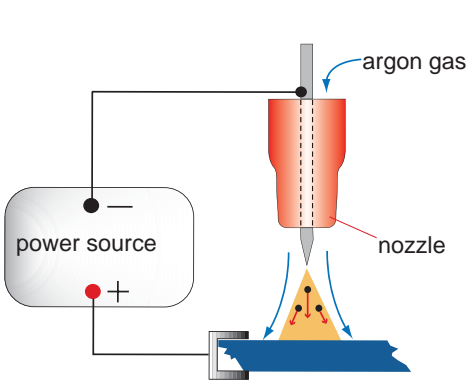

DC TIG welding is a process in which an arc is struck between a TUNGSTEN electrode and the metal work piece. The weld area is shielded by an inert gas flow to prevent contamination of the tungsten, molten pool and weld area.

When the TIG arc is struck the inert gas is ionized and superheated changing its molecular structure which converts it into a plasma stream. This plasma stream flowing between the tungsten and the work piece is the TIG arc and can be as hot as 19,000°C. It is a very pure and concentrated arc which provides the controlled melting of most metals into a weld pool. TIG welding offers the user the greatest amount of flexibility to weld the widest range of material and thickness and types. DC TIG welding is also the cleanest weld with no sparks or spatter.

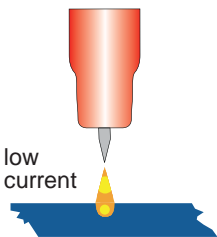

The intensity of the arc is proportional to the current that flows from the tungsten. The welder regulates the welding current to adjust the power of the arc. Typically thin material requires a less powerful arc with less heat to melt the material so less current (amps) is required, thicker material requires a more powerful arc with more heat so more current (amps) are necessary to melt the material.

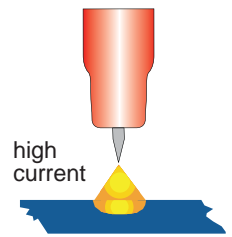

HF ARC IGNITION for TIG (tungsten inert gas) Welding

HF (high frequency) ignition allows the arc to be started in Tig welding without touching the tungsten to the work piece. By pressing the torch switch the machine will activate the gas flow and introduce the HF (high frequency) (high voltage) spark, this "ionizes" the air gap making it conductive allowing an arc to be created without touching the tungsten to the work piece. The gas molecules are superheated by the arc creating a stream of super heated gas that changes the molecular structure into producing a plasma stream. This plasma stream provides heat and energy that allows us to melt and fuse metals in an inert gas shielded environment know as TIG (tungsten inert gas) welding.

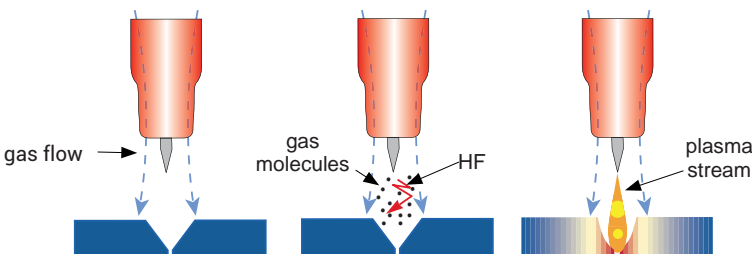

DC Pulse TIG Welding

Pulse TIG welding is when the current output (amperage) changes between high and low current. Electronics within the welding machine create the pulse cycle. Welding is done during the high-amperage interval (this high amperage is referred to as peak current). During the low amperage period, the arc is maintained but the current output of the arc is reduced (this low amperage is referred to as base current). During pulse welding the weld pool cools during the low amperage period. This allows a lower overall heat input into the base metal. It allows for controlled heating and cooling periods during welding providing better control of heat input, weld penetration, operator control and weld appearance.

There are 4 variables within the pulse cycle:

Peak Current - Base Current - Pulse Frequency - Pulse Width

Setting and manipulation of these variables will determine the nature of the weld current output and is at the discretion of the operator.

Peak Current is the main welding current (amps) set to melt the material being welded and works much the same as setting maximum amperage values for regular DC TIG: as a guide use 30-40 amps for every 1mm of material thickness.

Base Current is the set level of background current (amps) which cools the weld puddle and affects overall heat input. Background Amps is a percentage of peak amperage. As a rule, use enough background current to reduce the weld pool to about half its normal size while still keeping the weld pool fluid. As a guide start by setting the background amperage at 20 to 30 percent of peak amperage.

Pulse Frequency is the control of the amount of times per second (Hz) that the welding current switches from Peak Current to Base Current. DC Pulse TIG frequency generally ranges from 20 to 300 HZ depending on the job application. Control of the pulse frequency also determines the appearance of the weld.

Pulse Width is the control of the percentage of time during one pulsing cycle the power source spends at the peak current (main amperage). Example is with the Pulse Width set at 80 percent and a rate of 1 pulse per second (PPS), the machine will spend 80% of the pulse at peak amperage and 20% at the base current. Increasing the pulse width percentage adds more heat to the job, while decreasing pulse width percentage reduces heat

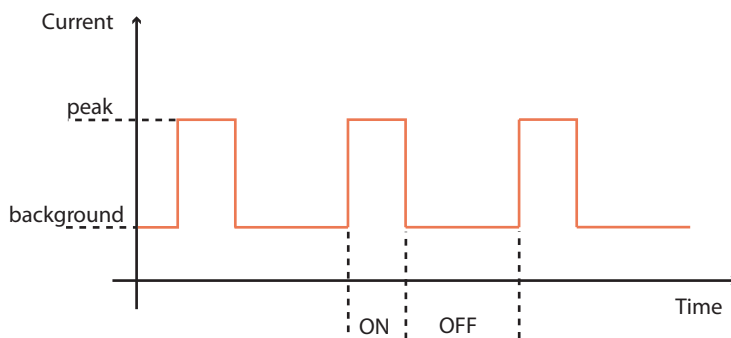

DC Pulse Tig welding allows faster welding speeds with better control of the heat input to the job, reducing the heat input minimising distortion and warping of the work and is of particular advantage in the welding of thin stainless steel and carbon steel applications. The high pulse frequency capability of the advanced inverter agitates the weld puddle and allows you to move quickly without transferring too much heat to the surrounding metal. Pulsing also constricts and focuses the arc thus increasing arc stability, penetration and travel speeds.

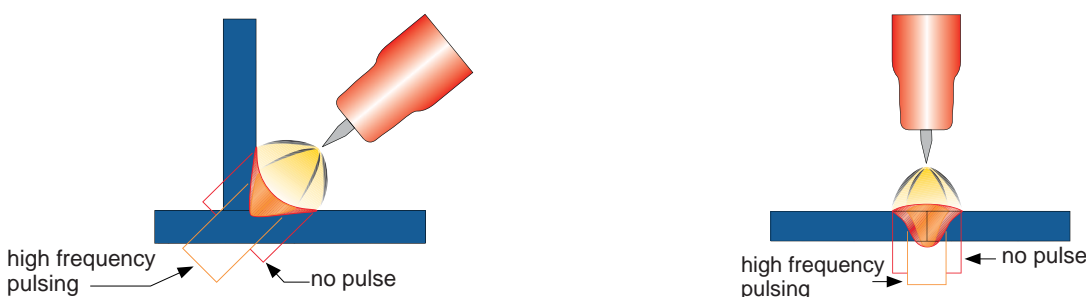

TIG Welding Fusion Technique

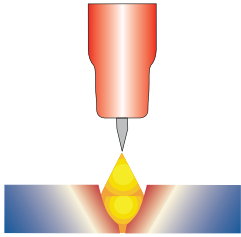

Manual TIG welding is often considered the most difficult of all the welding processes. Because the welder must maintain a short arc length, great care and skill are required to prevent contact between the electrode and the workpiece. Similar to Oxygen Acetylene torch welding, Tig welding normally requires two hands and in most instances requires the welder to manually feed a filler wire into the weld pool with one hand while manipulating the welding torch in the other. However, some welds combining thin materials can be accomplished without filler metal like edge, corner, and butt joints.

This is known as Fusion welding where the edges of the metal pieces are melted together using only the heat and arc force generated by the TIG arc. Once the arc is started the torch tungsten is held in place until a weld pool is created, a circular movement of the tungsten will assist in creating a weld pool of the desired size. Once the weld pool is established tilt the torch at about a 75° angle and move smoothly and evenly along the joint while fusing the materials together.

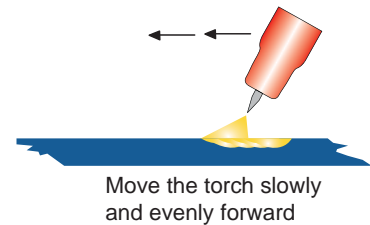
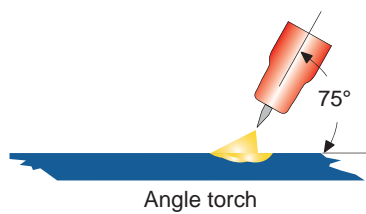
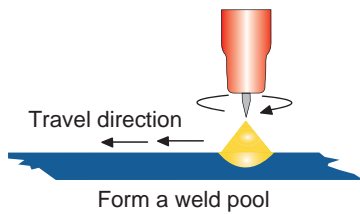

TIG Welding with Filler Wire Technique

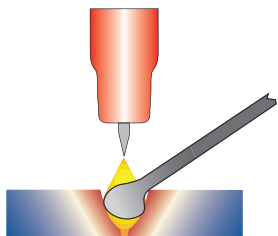

It is necessary in many situations with TIG welding to add a filler wire into the weld pool to build up weld reinforcement and create a strong weld. Once the arc is started the torch tungsten is held in place until a weld pool is created, a circular movement of the tungsten will assist in creating a weld pool of the desired size. Once the weld pool is established tilt the torch at about a 75° angle and move smoothly and evenly along the joint. The filler metal is introduced to the leading edge of the weld pool. The filler wire is usually held at about a 15° angle and fed into the leading edge of the molten pool,

the arc will melt the filler wire into the weld pool as the torch is moved forward. Also a dabbing technique can be used to control the amount of filler wire added, the wire is fed into the molten pool and retracted in a repeating sequence as the torch is moved slowly and evenly forward. It is important during the welding to keep the molten end of the filler wire inside the gas shield as this protects the end of the wire from being oxidised and contaminating the weld pool.

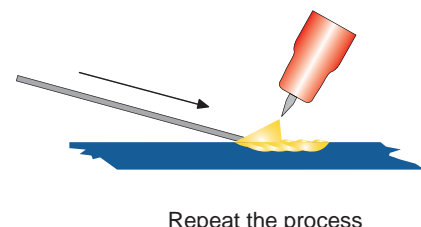
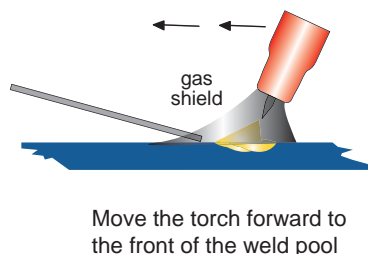
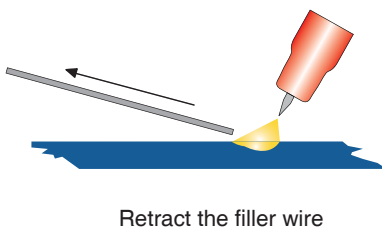
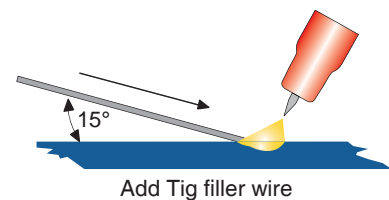
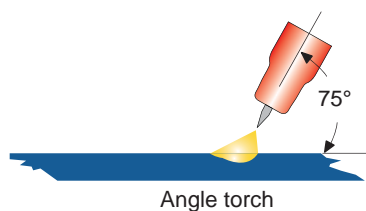
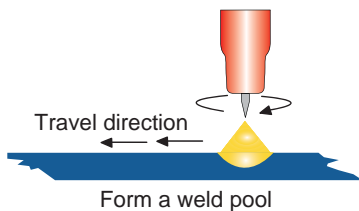

Tungsten Electrodes

Tungsten is a rare metallic element used for manufacturing TIG welding electrodes. The TIG process relies on tungsten's hardness and high-temperature resistance to carry the welding current to the arc. Tungsten has the highest melting point of any metal, 3,410 degrees Celsius. Tungsten electrodes are nonconsumable and come in a variety of sizes, they are made from pure tungsten or an alloy of tungsten and other rare earth elements. Choosing the correct tungsten depends on the material being welded, amps required and whether you are using AC or DC welding current. Tungsten electrodes are colour-coded at the end for easy identification. Below are the most commonly used tungsten electrodes found in the New Zealand and Australian market.

Thoriated

Thoriated tungsten electrodes (AWS classification EWTh-2) contain a minimum of 97.30 percent tungsten and 1.70 to 2.20 percent thorium and are called 2 percent thoriated. They are the most commonly used electrodes today and are preferred for their longevity and ease of use. Thorium however is a low-level radioactive hazard and many users have switched to other alternatives. Regarding the radioactivity, thorium is an alpha emitter but when it is enclosed in a tungsten matrix the risks are negligible. Thoriated tungsten should not get in contact with open cuts or wounds. The more significant danger to welders can occur when thorium oxide gets into the lungs. This can happen from the exposure to vapours during welding or from ingestion of material/dust in the grinding of the tungsten. Follow the manufacturer's warnings, instructions, and the Material Safety Data Sheet (MSDS) for its use.

E3 (Color Code: Turquoise)

E3 tungsten electrodes (AWS classification EWG) contain a minimum of 98% percent tungsten and up to 1.5 percent Lanthanum and small percentages of Zirconium and Yttrium they are called E3 Tungsten. E3 Tungsten Electrodes provide conductivity similar to that of thoriated electrodes. Typically, this means that E3 Tungsten Electrodes are exchangeable with thoriated electrodes without requiring significant welding process changes. E3 deliver superior arc starting, electrode lifetime, and overall cost-effectiveness. When E3 Tungsten Electrodes are compared with 2% thoriated tungsten, E3 requires fewer re-grinds and provides a longer overall lifetime. Tests have shown that ignition delay with E3 Tungsten Electrodes actually improves over time, while 2% thoriated tungsten starts to deteriorate after only 25 starts. At equivalent energy output, E3 Tungsten Electrodes run cooler than 2% thoriated tungsten, thereby extending overall tip lifetime. E3 Tungsten Electrodes work well on AC or DC. They can be used DC electrode positive or negative with a pointed end, or balled for use with AC power sources.

Ceriated (Color Code: Grey)

Ceriated tungsten electrodes (AWS classification EWCe-2) contain a minimum of 97.30 percent tungsten and 1.80 to 2.20 percent cerium and are referred to as 2 percent ceriated. Ceriated tungstens perform best in DC welding at low current settings. They have excellent arc starts at low amperages and become popular in such applications as orbital tube welding, thin sheet metal work. They are best used to weld carbon steel, stainless steel, nickel alloys, and titanium, and in some cases it can replace 2 percent thoriated electrodes. Ceriated tungsten is best suited for lower amperages it should last longer than Thoriated tungsten higher amperage applications are best left to Thoriated or Lanthanated tungsten.

Lanthanated (Color Code: Gold)

Lanthanated tungsten electrodes (AWS classification EWLa-1.5) contain a minimum of 97.80 percent tungsten and 1.30 percent to 1.70 percent lanthanum, and are known as 1.5 percent lanthanated. These electrodes have excellent arc starting, a low burn off rate, good arc stability, and excellent re-ignition characteristics. Lanthanated tungstens also share the conductivity characteristics of 2 percent thoriated tungsten. Lanthanated tungsten electrodes are ideal if you want to optimise your welding capabilities. They work well on AC or DC electrode negative with a pointed end, or they can be balled for use with AC sine wave power sources. Lanthanated tungsten maintains a sharpened point well, which is an advantage for welding steel and stainless steel on DC or AC from square wave power sources.

Zirconiated (Color Code: White)

Zirconiated tungsten electrodes (AWS classification EWZr-1) contain a minimum of 99.10 percent tungsten and 0.15 to 0.40 percent zirconium. Most commonly used for AC welding Zirconiated tungsten produces a very stable arc and is resistant to tungsten spitting. It is ideal for AC welding because it retains a balled tip and has a high resistance to contamination. Its current-carrying capacity is equal to or greater than that of thoriated tungsten. Zirconiated tungsten is not recommended for DC welding.

Tungsten Electrodes Rating for Welding Currents

Tungsten Diameter mm	DC Current Amps Torch Negative 2% Thoriated	AC Current Amps Un-Balanced Wave 0.8% Zirconiated	AC Current Amps Balanced Wave 0.8% Zirconiated
1.0mm	15 - 80	15 - 80	20 - 60
1.6mm	70 - 150	70 - 150	60 - 120
2.4mm	150 - 250	140 - 235	100 - 180
3.2mm	250 - 400	225 - 325	160 - 250
4.0mm	400 - 500	300 - 400	200 - 320

Tungsten Preparation

Always use **DIAMOND** wheels when grinding and cutting. While tungsten is a very hard material, the surface of a diamond wheel is harder, and this makes for smooth grinding. Grinding without diamond wheels, such as aluminium oxide wheels, can lead to jagged edges, imperfections, or poor surface finishes not visible to the eye that will contribute to weld inconsistency and weld defects.

Always ensure to grind the tungsten in a longitudinal direction on the grinding wheel. Tungsten electrodes are manufactured with the molecular structure of the grain running lengthwise and thus grinding crosswise is “grinding against the grain.” If electrodes are ground crosswise, the electrons have to jump across the grinding marks and the arc can start before the tip and wander. Grinding longitudinally with the grain, the electrons flow steadily and easily to the end of the tungsten tip. The arc starts straight and remains narrow, concentrated, and stable.



Electrode Tip/Flat

The shape of the tungsten electrode tip is an important process variable in precision arc welding. A good selection of tip/flat size will balance the need for several advantages. The bigger the flat, the more likely arc wander will occur and the more difficult it will be to arc start. However, increasing the flat to the maximum level that still allows arc start and eliminates arc wander will improve the weld penetration and increase the electrode life. Some welders still grind electrodes to a sharp point, which makes arc starting easier. However, they risk decreased welding performance from melting at the tip and the possibility of the point falling off into the weld pool.



Electrode Included Angle/Taper - DC Welding

Tungsten electrodes for DC welding should be ground longitudinally and concentrically with diamond wheels to a specific included angle in conjunction with the tip/flat preparation. Different angles produce different arc shapes and offer different weld penetration capabilities. In general, blunter electrodes that have a larger included angle provide the following benefits:

- Last Longer
- Have better weld penetration
- Have a narrower arc shape
- Can handle more amperage without eroding.

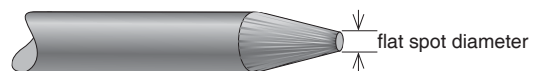

Sharper electrodes with smaller included angle provide:

- Offer less arc weld
- Have a wider arc
- Have a more consistent arc



The included angle determines weld bead shape and size. Generally, as the included angle increases, penetration increases and bead width decreases.

Tungsten Diameter	Diameter at the Tip - mm	Constant Included Angle - Degrees	Current Range Amps	Current Range Pulsed Amps
1.0mm	.250	20	05 - 30	05 - 60
1.6mm	.500	25	08 - 50	05 - 100
1.6mm	.800	30	10 - 70	10 - 140
2.4mm	.800	35	12 - 90	12 - 180
2.4mm	1.100	45	15 - 150	15 - 250
3.2mm	1.100	60	20 - 200	20 - 300
3.2mm	1.500	90	25 - 250	25 - 350

GAS FLOW REGULATORS

The job of the gas flow regulator is to reduce the bottle pressure gas down to a lower pressure and deliver it at a constant flow. This constant flow of gas is usually fed through the welding machine where it is controlled by a solenoid valve, operated when the torch trigger is pulled. Once the gas has passed the solenoid valve it flows down the torch cable exiting at the gas nozzle to protect the weld pool and surrounding area. There are two main types of flow regulators commonly used for MIG and TIG welding applications. Both regulator types perform the same function, but have a different way of setting and measuring the gas flow. A flow-gauge regulator (Fig.1) has a dial-type pressure gauge to measure the cylinder contents and a second gauge to measure and deliver the flow rate required. The flow-meter regulator (Fig.2) has a pressure gauge to measure the cylinder contents and a flow tube assembly to measure and deliver the flow rate required. Some flowmeter regulators will have two flow tube assemblies (Fig.3) typically one is used for supplying gas to the welding machine and the other is used used for purging the welding area with gas prior to welding, during welding and post welding and at a separate rate of flow from that being supplied to the welding machine. The amount of gas flow needed to do the job will depend on the welding gas and the job being done, but a common setting to start with is 10 L/min.



Fig.1



Fig.2

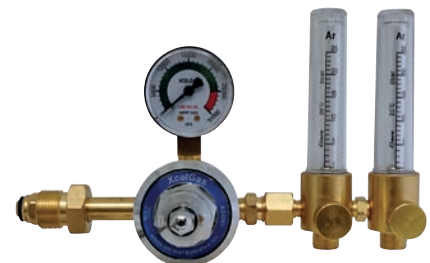

Fig.3

SHIELDING GASES

Shielding gases are almost always necessary for MIG and TIG welding processes to protect the weld zone from gases that are contained in the surrounding atmosphere, particularly nitrogen and oxygen. If allowed into the weld zone these gases will contaminate the weld pool resulting in fusion defects also porosity and embrittlement of the weld metal. Selecting the right type of shielding gas depends on the welding process being used and type of material being welded. The MIG process is typically a mixture of Argon and Co₂ (AR90% Co₂ 10%) or pure Co₂ for steel welding applications, other specialised mixtures of Argon, Co₂, and Oxygen are available for stainless steel welding but with welding aluminium pure Argon is almost always used. The TIG welding process almost always requires 100% Argon for welding of all materials, however in some specialised applications Helium, or a Helium mix are sometimes used. Today with the multitude of gas mixes available through a number of different suppliers, it is difficult to list and recommend which gas mix is better for which job. If you are unsure about what gas or gas mix to use we recommend you discuss with your application local gas suppliers or your Esseti technical representative.

GAS FLOW RATES

For MIG applications the ideal gas flow rate will depend on the type of mig wire, wire feed speed and current being used and also the type metal transfer mode, i.e. Dip Transfer, Spray, Pulse Mig. Long interconnecting cables between the power source and wire feeder and also long push pull torch cables may require higher flow rates to compensate for the distance. As a general rule of thumb;

1. Small weld pools use 10 L/min,
2. Medium weld pools up to 15 L/min
3. Large spray, pulse mig weld pools use up to 25 L/min.

It is important to note that too high gas flow can be just as bad as having too low flow rate. The reason being that if the gas flow exits the gas nozzle a too high rate it can.

1. create a vortex and draw air into the gas flow and the weld zone causing contamination of the weld.
2. produce turbulence at the weld pool resulting in a poor quality weld.

XA36 MIG TORCH & SPARES



XA36 MIG TORCH

Suregrip™ Series

300A AIR COOLED MIG WELDING TORCH

Rating: 300A CO₂ 270A mixed gas EN60974-7 @ 60% duty cycle. 0.8 to 1.2mm wires

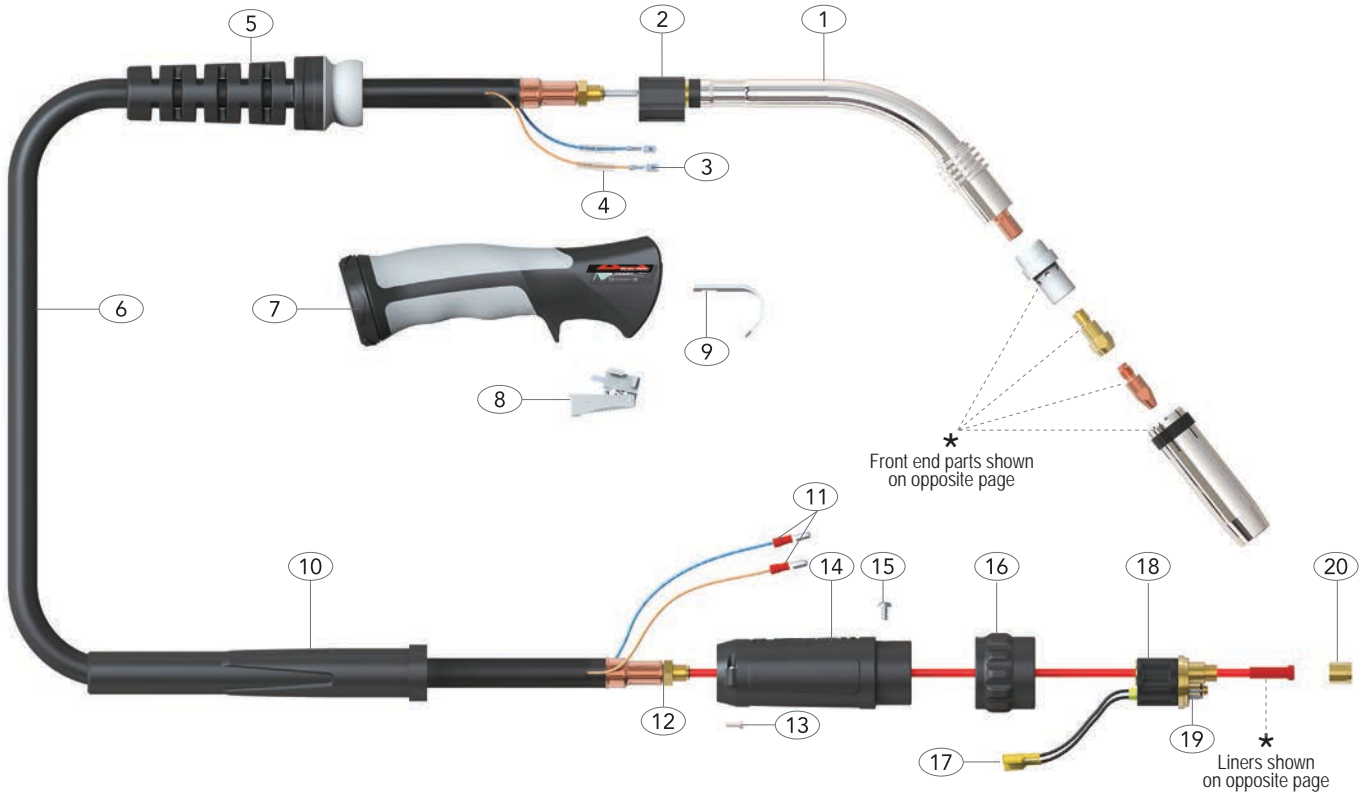

Torch Model	Description			
Description	Part Number	3 Mt	4 Mt	5 Mt
XA36 Suregrip Ergo Torch Package	XA36-3		XA36-4	XA36-5

Spare Parts		
Part Number	Description	
1	XA3603	Torch neck XA36
2	XA1515	Ergo Handle Location Body
3	XA1521	Cable Terminal
4	XA1521-C	Cable Terminal Cover
5	XA8016	Cable Support c/w Ball Joint
6	XA3609-03	Duraflex Cable Assembly x 3m
	XA3609-04	Duraflex Cable Assembly x 4m
	XA3609-05	Duraflex Cable Assembly x 5m
7	XA2514	Ergo Handle Kit c/w Lock Nut
8	XA2516	Medium /Large Trigger
9	XA2517	Hanger Hook (optional extra)
10	XA3541	Cable Support
11	XA1522	Cable Terminal - Male
12	XA1505	Lock Nut
13	XASCSP1-1	Gun Plug Housing Screw
14	XASC2578/S	Gun Plug Housing
15	XA1541	Gun Plug Screw

Spare Parts		
Part Number	Description	
16	XA1519/S	Gun Plug Nut
17	XA1523	Gun Plug Terminal Female
18	XA1528	Gun Plug Body c/w Spring
Pins		
19	XA1524	Gun Plug O-Ring
20	XA1525	Liner Nut

XA36 MIG TORCH CONSUMABLES

Suregrip™ Series

Front end consumables

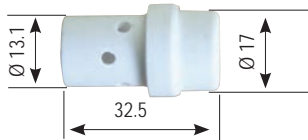
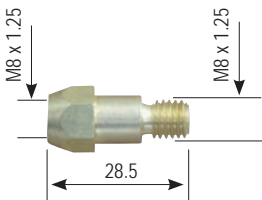
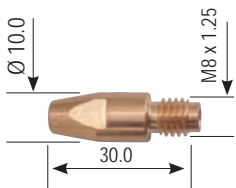
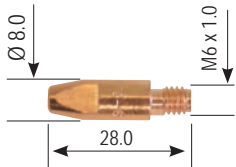

XA36 Contact Tips M6

Part Number	Description
XA2504-06	Contact Tip ECu 0.6mm D6 M6 x 28mm
XA2504-08	Contact Tip ECu 0.8mm D8 M6 x 28mm
XA2504-09	Contact Tip ECu 0.9mm D8 M6 x 28mm
XA2504-10	Contact Tip ECu 1.0mm D8 M6 x 28mm
XA2504-12	Contact Tip ECu 1.2mm D8 M6 x 28mm
XA2504-16	Contact Tip ECu 1.6mm D8 M6 x 28mm
XA2504-10A	Contact Tip ECu 1.0Amm D8 M6 x 28mm (for Aluminium)
XA2504-12A	Contact Tip ECu 1.2Amm D8 M6 x 28mm (for Aluminium)
XA2504-16A	Contact Tip ECu 1.6Amm D8 M6 x 28mm (for Aluminium)

XA36 Contact Tips M8

Part Number	Description
XA4014-08	Contact Tip ECu 0.8mm D10 M8 x 30mm
XA4014-09	Contact Tip ECu 0.9mm D10 M8 x 30mm
XA4014-10	Contact Tip ECu 1.0mm D10 M8 x 30mm
XA4014-12	Contact Tip ECu 1.2mm D10 M8 x 30mm
XA4014-16	Contact Tip ECu 1.6mm D10 M8 x 30mm
XA4014-20	Contact Tip ECu 2.0mm D10 M8 x 30mm
XA4014-10A	Contact Tip ECu 1.0Amm D10 M8 x 30mm (for Aluminium)
XA4014-12A	Contact Tip ECu 1.2Amm D10 M8 x 30mm (for Aluminium)
XA4014-16A	Contact Tip ECu 1.6Amm D10 M8 x 30mm (for Aluminium)

XA36 Tip Holder

Part Number	Description	Tip Thread	Material
XA3612	XA36 Tip Holder L = 28.5mm	M6	Brass
XA3614	XA36 Tip Holder L = 28.5mm	M8	Brass

Gas Diffuser XA36

Part Number	Description	Colour	Material
XA3605W	XA36 Gas Diffuser L = 32.5mm	White	DMC3
XA3605C	XA36 Gas Diffuser L = 32.5mm	White	Ceramic
XA3605B	XA36 Gas Diffuser L = 32.5mm	Black	DMC3
XA3605H	XA36 Gas Diffuser High Temp	Black	HPP

XA36 Gas Nozzle

Part Number	Description	Type	Bore Ø	Material
XA3615	XA36 Gas Nozzle	Cylindrical	19.0mm	Copper
XA3616	XA36 Gas Nozzle	Conical	16.0mm	Copper
XA3617	XA36 Gas Nozzle	Tapered	12.0mm	Copper

XA36 Liners

Part Number	Description
XA2524-30B	Insulated Liner 0.9-1.2mm wire x 3.4m (Red)
XA2524-40B	Insulated Liner 0.9-1.2mm wire x 4.4m (Red)
XA2524-50B	Insulated Liner 0.9-1.2mm wire x 5.4m (Red)
XA3631-30B	Insulated Liner 1.6mm wire x 3.4m (Yellow)
XA3631-40B	Insulated Liner 1.6mm wire x 4.4m (Yellow)
XA3631-50B	Insulated Liner 1.6mm wire x 5.4m (Yellow)
XA2513-30B	Teflon Liner 1.0-1.2mm x 3.4m for Soft wire
XA2513-40B	Teflon Liner 1.0-1.2mm x 4.4m for Soft wire
XA2513-50B	Teflon Liner 1.0-1.2mm x 5.4m for Soft wire
XAPA0812-4.0-30	PA Liner 3m c/w Brass Neck 0.8 -1.2mm, 4.0mm Ø For RZ, VP
XAPA0812-4.0-40	PA Liner 4m c/w Brass Neck 0.8 -1.2mm, 4.0mm Ø For RZ, VP
XAPA1216-4.7-30	PA Liner 3m c/w Brass Neck 1.2-1.6mm, 4.7mm Ø
XAPA1216-4.7-40	PA Liner 4m c/w Brass Neck 1.2-1.6mm, 4.7mm Ø
XAPA1620-4.7-30	PA Liner 3m c/w Brass Neck 1.6-2.0mm, 4.7mm Ø
XAPA1620-4.7-40	PA Liner 4m c/w Brass Neck 1.6-2.0mm, 4.7mm Ø

Liners



XASP36 SPOOL GUN & SPARES



270A AIR COOLED SPOOL ON GUN MIG WELDING TORCH
 Rating: 270A CO₂ 250A mixed gas EN60974-7 @ 60% duty cycle. 0.8 to 1.2mm wires

Suregrip™ Series

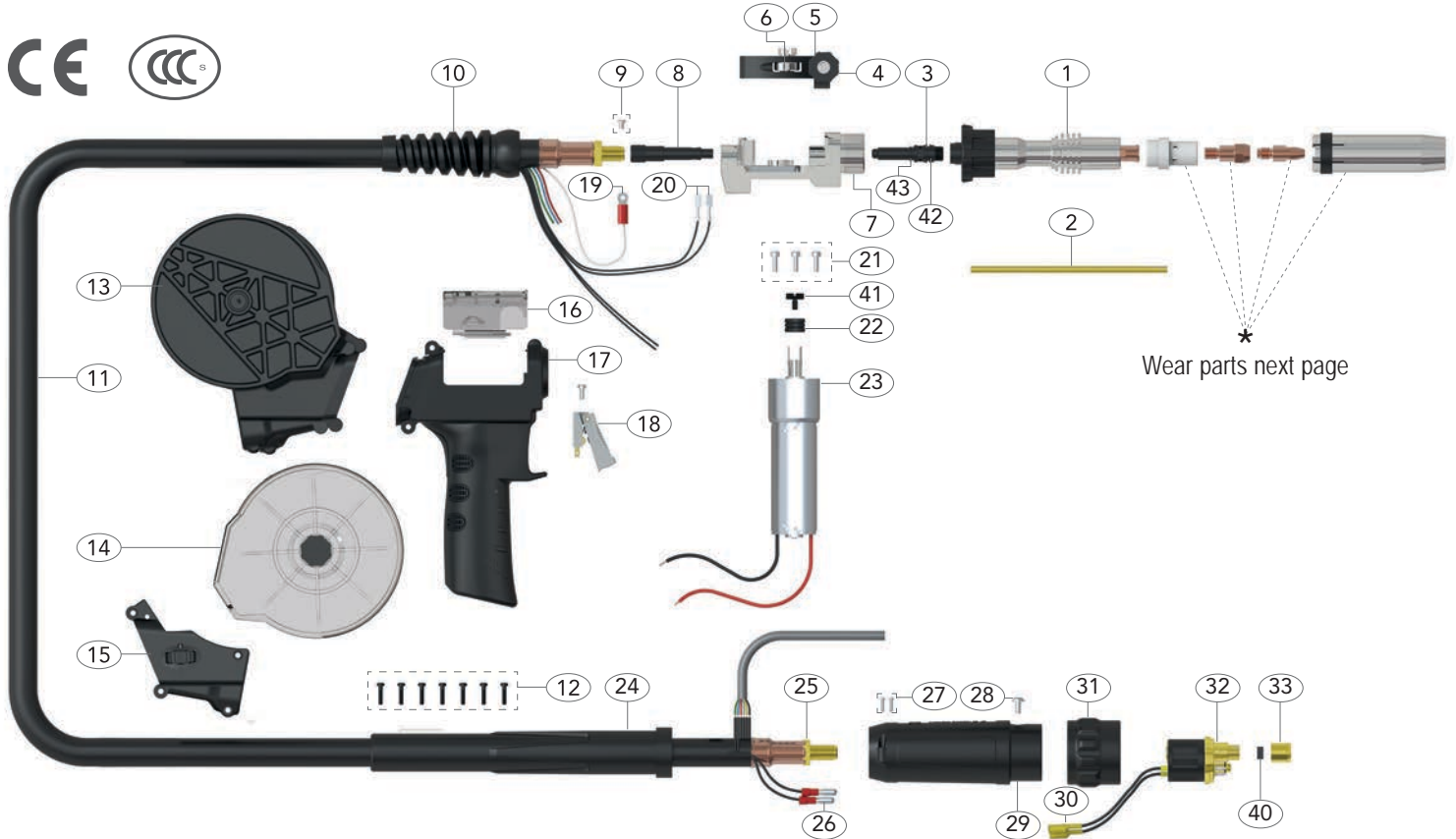

* Wear parts next page

Torch Model	Part Number	Description
XASP36-24-P1-60ER	XASP36-24-P1-60ER	XA Suregrip Spool Gun 270A x 6m, 1K Pot, 24V Motor

Spare Parts		
Part Number	Description	
1	XAP3603A	Straight Neck Assembly
2	XAP3602A	Jump Liner
3	XAP36006	Jump Liner Nipple
4	XAP36402B	Tension Knob
5	XAP36402	Pressure Arm Assembly
6	XAP36402R	Pressure Roll
7	XAP36001	Motor Body
8	XAP36006	Wire Guide
9	XA2563	Screw
10	XA8015	Cable Support
11	XASP3609-60ER	Coax Cable Assembly, Euro Type
12	XAA3X20	Handle Screw Pack
13	XAP2515SP-B	Spool Box
14	XAP2515SP-C	Spool Cover
15	XAP2515SP-PT-1K	Wire Speed Control 1KΩ
	XAP2515SP-PT-5K	Wire Speed Control 5KΩ
	XAP2515SP-PT-10K	Wire Speed Control 10KΩ
16	XAP2514/C	Spool Gun Handle Cover
17	XAP2515/KJ	Spool Gun Handle
18	XAP2516	Push Pull Trigger
19	XA2597	Circular Cold Press Terminal
20	XA1521	Cable Terminal
21	XAPMS1	Motor Screw Pack

Spare Parts		
Part Number	Description	
22	XAP7020W-08U	Driver Roll For Aluminium Wire 0.8
	XAP7020W-09U	Driver Roll For Aluminium Wire 0.9
	XAP7020W-10U*	Driver Roll For Aluminium Wire 1.0
	XAP7020W-12U	Driver Roll For Aluminium Wire 1.2
	XAP7020W-16U	Driver Roll For Aluminium Wire 1.6
23	XAP7020-24	Motor 24V DC
	XAP7020-42	Motor 42V DC
24	XAA3541	Cable Support
25	XA1505	Lock Nut
26	XA1522	Cable Terminal Male
27	XASP1-1	Gun Plug Housing Screw
28	XA1541	Gun Plug Screw
29	XA2578H/L	Gun Plug Housing Assembly
30	XA1523	Gun Plug Terminal Female
31	XA1519/S	Housing Nut
32	XA1528	Hybrid Gun Plug Body with Pins
33	XA1525	Retaining Nut
40	XA1525W	Washer

*Supplied standard with 1.0mm U Groove for Alloy Wire!

XASP36 MIG TORCH CONSUMABLES

Suregrip™ Series

Front end consumables

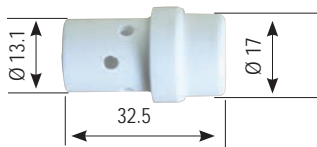
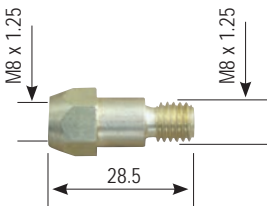
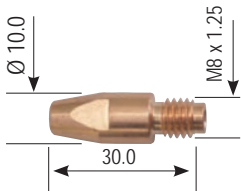
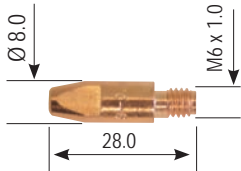

XA36 Contact Tips M6

Part Number	Description
XA2504-06	Contact Tip ECu 0.6mm D6 M6 x 28mm
XA2504-08	Contact Tip ECu 0.8mm D8 M6 x 28mm
XA2504-09	Contact Tip ECu 0.9mm D8 M6 x 28mm
XA2504-10	Contact Tip ECu 1.0mm D8 M6 x 28mm
XA2504-12	Contact Tip ECu 1.2mm D8 M6 x 28mm
XA2504-16	Contact Tip ECu 1.6mm D8 M6 x 28mm
XA2504-10A	Contact Tip ECu 1.0Amm D8 M6 x 28mm (for Aluminium)
XA2504-12A	Contact Tip ECu 1.2Amm D8 M6 x 28mm (for Aluminium)
XA2504-16A	Contact Tip ECu 1.6Amm D8 M6 x 28mm (for Aluminium)

XA36 Contact Tips M8

Part Number	Description
XA4014-08	Contact Tip ECu 0.8mm D10 M8 x 30mm
XA4014-09	Contact Tip ECu 0.9mm D10 M8 x 30mm
XA4014-10	Contact Tip ECu 1.0mm D10 M8 x 30mm
XA4014-12	Contact Tip ECu 1.2mm D10 M8 x 30mm
XA4014-16	Contact Tip ECu 1.6mm D10 M8 x 30mm
XA4014-20	Contact Tip ECu 2.0mm D10 M8 x 30mm
XA4014-10A	Contact Tip ECu 1.0Amm D10 M8 x 30mm (for Aluminium)
XA4014-12A	Contact Tip ECu 1.2Amm D10 M8 x 30mm (for Aluminium)
XA4014-16A	Contact Tip ECu 1.6Amm D10 M8 x 30mm (for Aluminium)

XA36 Tip Holder

Part Number	Description	Tip Thread	Material
XA3612	XA36 Tip Holder L = 28.5mm	M6	Brass
XA3614	XA36 Tip Holder L = 28.5mm	M8	Brass

Gas Diffuser XA36

Part Number	Description	Colour	Material
XA3605W	XA36 Gas Diffuser L = 32.5mm	White	DMC3
XA3605C	XA36 Gas Diffuser L = 32.5mm	White	Ceramic
XA3605B	XA36 Gas Diffuser L = 32.5mm	Black	DCM3
XA3605H	XA36 Gas Diffuser High Temp	Black	HPP

XA36 Gas Nozzle

Part Number	Description	Type	Bore Ø	Material
XA3615	XA36 Gas Nozzle	Cylindrical	19.0mm	Copper
XA3616	XA36 Gas Nozzle	Conical	16.0mm	Copper
XA3617	XA36 Gas Nozzle	Tapered	12.0mm	Copper

XAP360 PUSH-PULL TORCH & SPARES



300A AIR COOLED MIG WELDING TORCH

Rating: 300A CO₂ 270A mixed gas EN60974-7 @ 60% duty cycle. 0.8 to 1.2mm wires

Suregrip™ Series

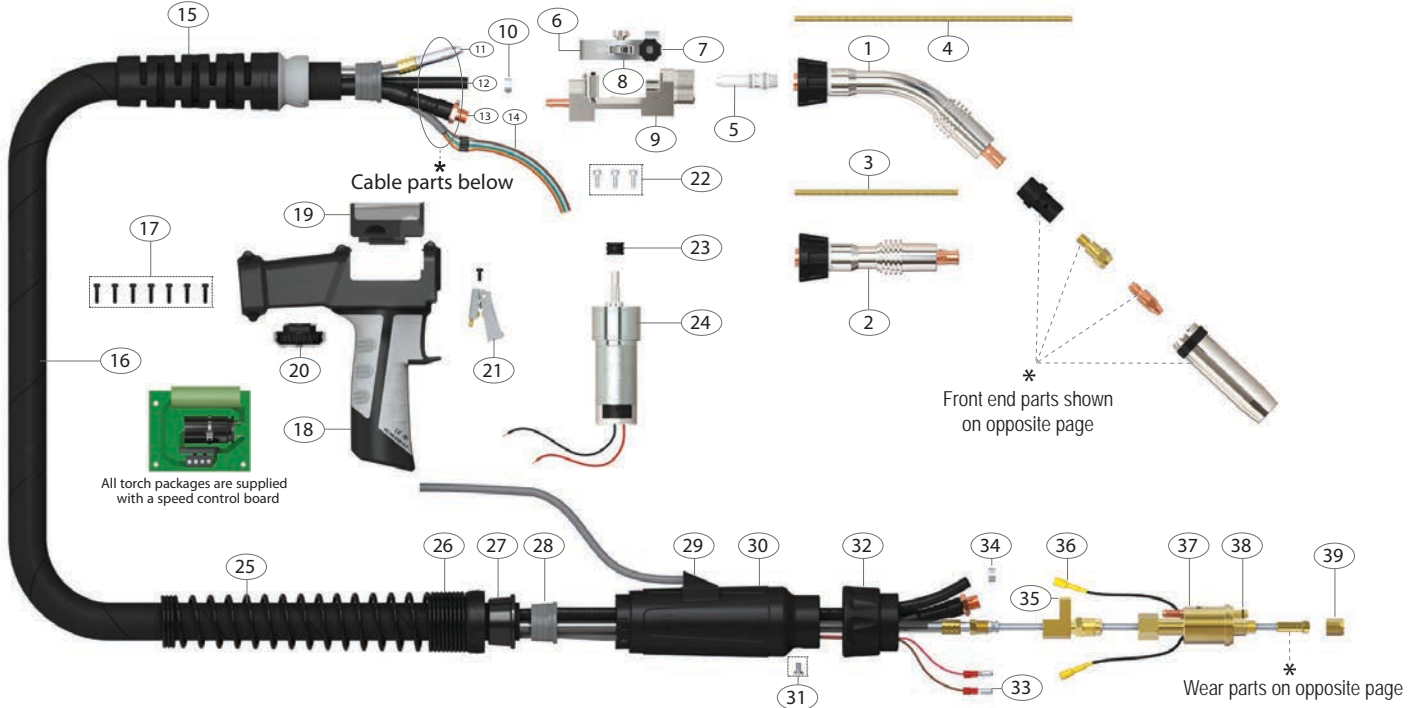

Torch Model	Part Number
-------------	-------------

XAP360 Suregrip™ 42v Push Pull Mig Torch Package 45° Neck x 8m	XAP3600-42-A45-80ER
XAP360 Suregrip™ 42v Push Pull Mig Torch Package Straight Neck x 8m	XAP3600-42-A180-80ER
XAP360 Suregrip™ 24v Push Pull Mig Torch Package 45° Neck x 8m	XAP3600-24-A45-80ER
XAP360 Suregrip™ 24v Push Pull Mig Torch Package Straight Neck x 8m	XAP3600-24-A180-80ER

Spare Parts		
Part Number	Description	

1	XAP3603	Swan Neck Assembly 45°
2	XAP3603A	Straight Neck Assembly
3	XAP3602	Jump Liner
4	XAP3602A	Jump Liner
5	XAP36006	Jump Liner Nipple
6	XAP36402	Pressure Arm Assembly
7	XAP36402B	Tension Knob
8	XAP36402R	Pressure Roll
9	XAP36001	Motor Body
10	XA5041	Water Hose Clamp 8.7mm
15	XA3208	Handle Cable Support
16	XAP36419-80	Canvas Cover Assembly
17	XASP1	Handle Screw
18	XAP2514/KJ	Push Pull Handle
19	XAP2514/C	Push Pull Handle Cover
20	XAP0807-1	Potentiometer Kit 1K
	XAP0807-5	Potentiometer Kit 5K
	XAP0807-10	Potentiometer Kit 10K
	XAP0807-25	Potentiometer Kit 25K
21	XAP2516	Trigger
22	XAPMS1	Motor Screw
23	XAP8224W-08	Drive Roll For Wire 0.8
	XAP8224W-09	Drive Roll For Wire 0.9
	XAP8224W-10	Drive Roll For Wire 1.0
	XAP8224W-12	Drive Roll For Wire 1.2

Spare Parts		
Part Number	Description	

23	XAP8224W-09U	Drive Roll U Groove 0.9mm
	XAP8224W-10U	Drive Roll U Groove 1.0mm
	XAP8224W-12U	Drive Roll U Groove 1.2mm
24	XAP8224-24	Motor 24V DC
	XAP8224-42	Motor 42V DC
25	XA8027	Housing Spring
26	XA8028	Spring Cable Support Nut
27	XA8009	Canvas Cover Clamp
28	XA8010	Canvas Cover Retainer
29	XALH26-C	Housing Insert
30	XA5022	Gun Plug Housing Assembly
31	XA1526	Gun Plug Screw
32	XA1519/S	Gun Plug Nut
33	XA1522	Cable Terminal Male
34	XA5024	Water Hose Clamp 9.5MM
35	XAP3608C	Power Fitting
36	XA1523	Gun Plug Terminal Female
37	XAP1528	A/C Gun Plug Body Assembly
38	XA1524	Gun Plug 'O' Ring
39	XA1525	Liner Nut

Cable Parts		
Part Number	Description	

11	XAP36408-80	Outer Liner Assembly
12	XAP36413-80	Gas Hose Assembly
13	XAP36015-80	Power Cable Assembly
14	XAP36410-80	Switch Lead Assembly

XAP360 PUSH-PULL TORCH & SPARES

RazorWeld

XAP360 MIG TORCH CONSUMABLES

Suregrip™ Series

Front end consumables

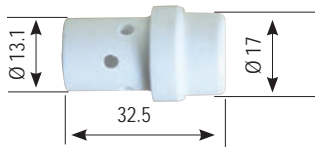
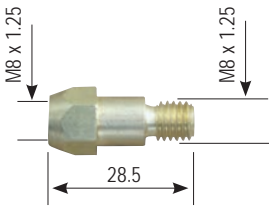
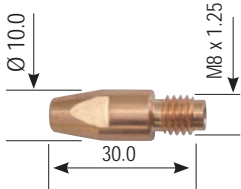
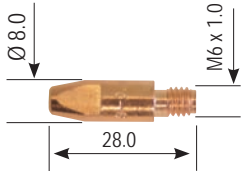

XA36 Contact Tips M6

Part Number	Description
XA2504-06	Contact Tip ECu 0.6mm D6 M6 x 28mm
XA2504-08	Contact Tip ECu 0.8mm D8 M6 x 28mm
XA2504-09	Contact Tip ECu 0.9mm D8 M6 x 28mm
XA2504-10	Contact Tip ECu 1.0mm D8 M6 x 28mm
XA2504-12	Contact Tip ECu 1.2mm D8 M6 x 28mm
XA2504-16	Contact Tip ECu 1.6mm D8 M6 x 28mm
XA2504-10A	Contact Tip ECu 1.0Amm D8 M6 x 28mm (for Aluminium)
XA2504-12A	Contact Tip ECu 1.2Amm D8 M6 x 28mm (for Aluminium)
XA2504-16A	Contact Tip ECu 1.6Amm D8 M6 x 28mm (for Aluminium)

XA36 Contact Tips M8

Part Number	Description
XA4014-08	Contact Tip ECu 0.8mm D10 M8 x 30mm
XA4014-09	Contact Tip ECu 0.9mm D10 M8 x 30mm
XA4014-10	Contact Tip ECu 1.0mm D10 M8 x 30mm
XA4014-12	Contact Tip ECu 1.2mm D10 M8 x 30mm
XA4014-16	Contact Tip ECu 1.6mm D10 M8 x 30mm
XA4014-20	Contact Tip ECu 2.0mm D10 M8 x 30mm
XA4014-10A	Contact Tip ECu 1.0Amm D10 M8 x 30mm (for Aluminium)
XA4014-12A	Contact Tip ECu 1.2Amm D10 M8 x 30mm (for Aluminium)
XA4014-16A	Contact Tip ECu 1.6Amm D10 M8 x 30mm (for Aluminium)

XA36 Tip Holder

Part Number	Description	Tip Thread	Material
XA3612	XA36 Tip Holder L = 28.5mm	M6	Brass
XA3614	XA36 Tip Holder L = 28.5mm	M8	Brass

Gas Diffuser XA36

Part Number	Description	Colour	Material
XA3605W	XA36 Gas Diffuser L = 32.5mm	White	DMC3
XA3605C	XA36 Gas Diffuser L = 32.5mm	White	Ceramic
XA3605B	XA36 Gas Diffuser L = 32.5mm	Black	DCM3
XA3605H	XA36 Gas Diffuser High Temp	Black	HPP

XA36 Gas Nozzle

Part Number	Description	Type	Bore Ø	Material
XA3615	XA36 Gas Nozzle	Cylindrical	19.0mm	Copper
XA3616	XA36 Gas Nozzle	Conical	16.0mm	Copper
XA3617	XA36 Gas Nozzle	Tapered	12.0mm	Copper

XAP360 Liners

Part Number	Description
XA5033-80B	Steel Liner 1.0-1.2mm wire x 8.5m Brass Nipple
XA5034-80B	Steel Liner 1.2-1.6mm wire x 8.5m Brass Nipple
XA2513-80	Teflon Liner 1.0-1.2mm wire x 8.6m Brass Nipple
XAPA0812-4.0-80	PA Liner 8m c/w Brass Neck 0.8 -1.2mm, 4.0mm Ø For RZ, VP
XAPA1216-4.7-80	PA Liner 8m c/w Brass Neck 1.2-1.6mm, 4.7mm Ø
XAPA1620-4.7-80	PA Liner 8m c/w Brass Neck 1.6-2.0mm, 4.7mm Ø

Liners

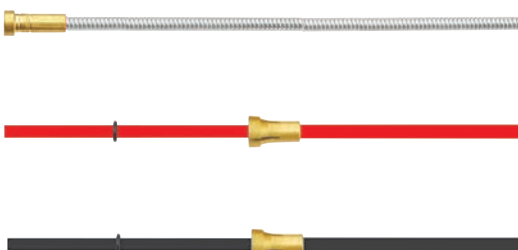

XA26V TIG TORCH & SPARES



XA26V TIG TORCH Suregrip™ Series

180AMP AIR COOLED

Gas Valve Torch Head

Rating: 180A DC, 125AAC @35% duty cycle.

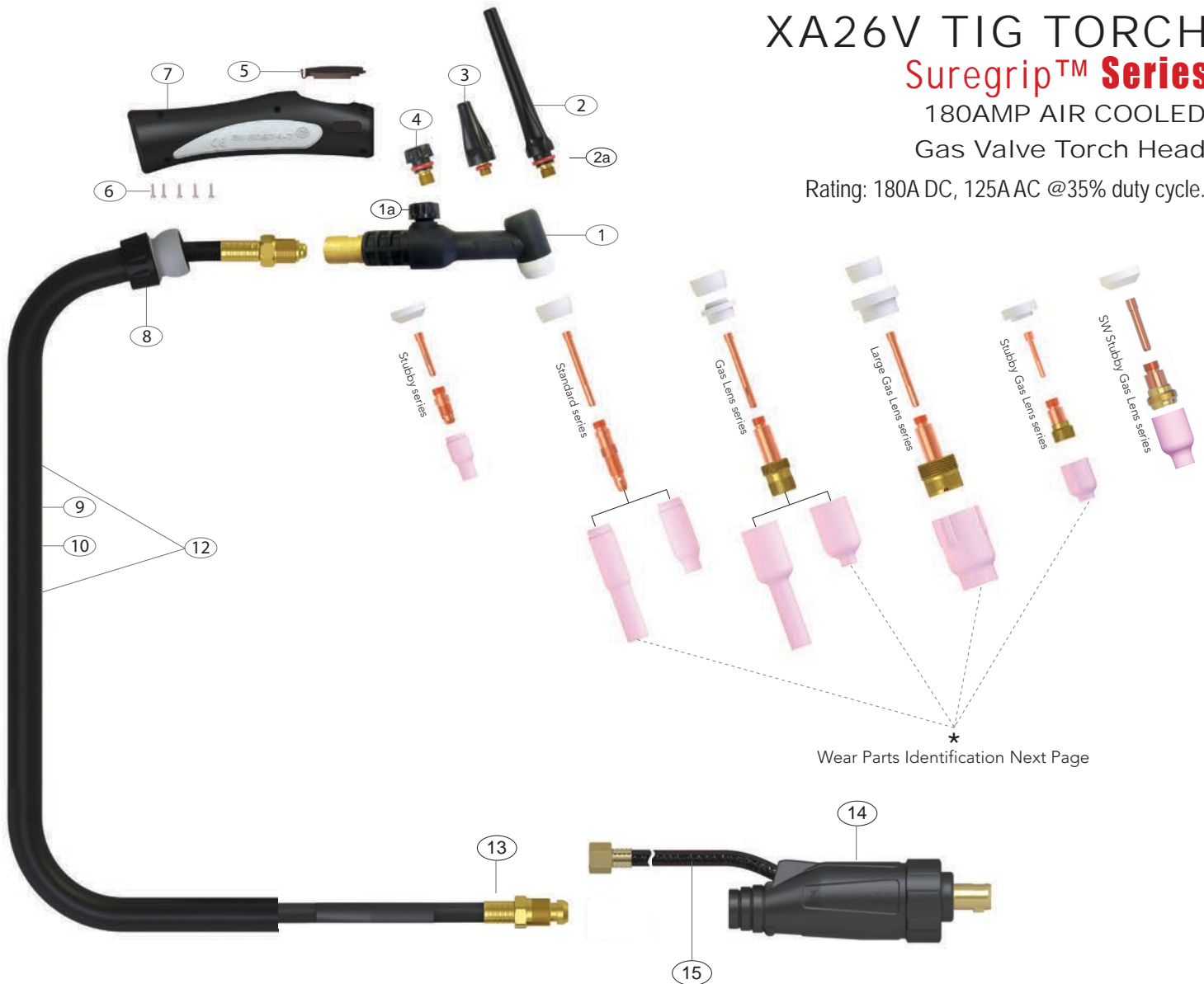

Wear Parts Identification Next Page

Torch Model Description	Part Number	
	4m	8m
XA26V Suregrip Tig Torch 4m, Surelok Connector QF Gas	XA26V-S112GS4	XA26V-S125GS4
XA26VFX Suregrip Flexi Tig Torch, Surelok Connector, QF Gas	XA26VFX-S112GS4	XA26VFX-S125GS4

Spare Parts		
Part Number	Description	
1	XA26V	Torch Body with Valve
1a	XA26VFX	Torch Body Flexible with Valve
2	57Y02	Back Cap Long
2a	98W18	Back Cap O Ring
3	57Y05	Back Cap Medium
4	57Y04	Back Cap Short
5	ERBS	Blank Switch Cover (See page 174 for Switch options)
6	ERSP1	Screw Pack
7	ERH200	Large Ergo Tig Handle
8	ERKJ200	Large Knuckle Joint
9	ERLC100-08	Leather Cover x 0.8m
10	ERJK200	Joining Repair Kit

Spare Parts		
Part Number	Description	
12	ERCO200-40	Sheath x 4m c/w Leather Cover
	ERCO200-80	Sheath x 8m c/w Leather Cover
13	SL46V28AOB	Power Cable x 4m Surelok OB Rubber
	SL46V30AOB	Power Cable x 8m Surelok OB Rubber
14	UD1025-38	Dinse Tig Power Cable Connector 10-25
	UD3550-38	Dinse Tig Power Cable Connector 35-50
15	WGCP-1V-58	Gas Hose Assembly x 2m

XA26V TIG TORCH & SPARES





Standard Front End Parts

				
18CG Cup Gasket	10N22 Collet 1.0mm 10N23 Collet 1.6mm 10N24 Collet 2.4mm 10N25 Collet 3.2mm	10N30 Collet Body 1.0mm 10N31 Collet Body 1.6mm 10N32 Collet Body 2.4mm 10N28 Collet Body 3.2mm	10N50 Alumina Nozzle Ø 6mm #4 10N49 Alumina Nozzle Ø 8mm #5 10N48 Alumina Nozzle Ø 10mm #6 10N47 Alumina Nozzle Ø 11mm #7 10N46 Alumina Nozzle Ø 12.5mm #8 10N45 Alumina Nozzle Ø 16mm #10 10N44 Alumina Nozzle Ø 19mm #12	10N49L Long Alumina Nozzle Ø 8mm #5L 10N48L Long Alumina Nozzle Ø 10mm #6L 10N47L Long Alumina Nozzle Ø 11mm #7L





Stubby Front End Parts

				
18CG20 Stubby Cup Gasket	10N22S Stubby Collet 1.0mm 10N23S Stubby Collet 1.6mm 10N24S Stubby Collet 2.4mm 10N25S Stubby Collet 3.2mm	17CB20 Stubby Collet Body Fits 1.0 - 3.2mm	13N08 Alumina Nozzle Ø 6mm #4 13N09 Alumina Nozzle Ø 8mm #5 13N10 Alumina Nozzle Ø 10mm #6 13N11 Alumina Nozzle Ø 11mm #7 13N12 Alumina Nozzle Ø 13mm #8 13N13 Alumina Nozzle Ø 16mm #10	796F70 Long Alumina Nozzle Ø 5mm #3 796F71 Long Alumina Nozzle Ø 6mm #4 796F72 Long Alumina Nozzle Ø 8mm #5 796F73 Long Alumina Nozzle Ø 10mm #6



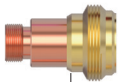

Ultra Stubby Gas Lens Front End Parts

			
USTB80300236 Gas Lens Gasket	10N22S Stubby Collet 1.0mm 10N23S Stubby Collet 1.6mm 10N24S Stubby Collet 2.4mm 10N25S Stubby Collet 3.2mm	USTB45V43 Stubby Gas Lens Body 1.6mm USTB45V44 Stubby Gas Lens Body 2.4mm USTB45V45 Stubby Gas Lens Body 3.2mm	53N58 Gas Lens Nozzle Ø 6mm #4 53N59 Gas Lens Nozzle Ø 8mm #5 53N60 Gas Lens Nozzle Ø 10mm #6 53N61 Gas Lens Nozzle Ø 11mm #7 53N61S Gas Lens Nozzle Ø 12.5mm #8

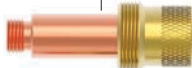

SW Stubby Gas Lens Front End Parts

			
18CG20 Stubby Cup Gasket	10N22S Stubby Collet 1.0mm 10N23S Stubby Collet 1.6mm 10N24S Stubby Collet 2.4mm 10N25S Stubby Collet 3.2mm	45V24S SW Stubby Gas Lens Body 1.0mm 45V25S SW Stubby Gas Lens Body 1.6mm 45V26S SW Stubby Gas Lens Body 2.4mm 45V27S SW Stubby Gas Lens Body 3.2mm	54N16SW Gas Lens Nozzle Ø 10mm #6 54N15SW Gas Lens Nozzle Ø 11mm #7 54N14SW Gas Lens Nozzle Ø 12.5mm #8 54N12SW Gas Lens Nozzle Ø 16.0mm #10

Gas Lens Front End Parts

					
18CG Cup Gasket 54N01 Gas Lens Gasket		45V24 Gas Lens Collet Body 1.0mm 45V25 Gas Lens Collet Body 1.6mm 45V26 Gas Lens Collet Body 2.4mm 45V27 Gas Lens Collet Body 3.2mm		54N18 Gas Lens Nozzle Ø 6mm #4 54N17 Gas Lens Nozzle Ø 8mm #5 54N16 Gas Lens Nozzle Ø 10mm #6 54N15 Gas Lens Nozzle Ø 11mm #7 54N14 Gas Lens Nozzle Ø 12.5mm #8 54N19 Gas Lens Nozzle Ø 17mm #11	54N18L Long Gas Lens Nozzle Ø 6mm #4L 54N17L Long Gas Lens Nozzle Ø 8mm #5L 54N16L Long Gas Lens Nozzle Ø 10mm #6L 54N15L Long Gas Lens Nozzle Ø 11mm #7L 54N14L Long Gas Lens Nozzle Ø 12.5mm #8L

Large Gas Lens Front End Parts

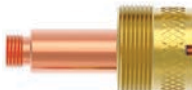
				
18CG Cup Gasket 54N63 Large Lens Gasket		10N22 Collet 1.0mm 10N23 Collet 1.6mm 10N24 Collet 2.4mm 10N25 Collet 3.2mm	45V0204 Large Gas Lens Body 1.0mm 45V116 Large Gas Lens Body 1.6mm 45V64 Large Gas Lens Body 2.4mm 995795 Large Gas Lens Body 3.2mm	57N75 Large Gas Lens Nozzle Ø 10mm #6 57N74 Large Gas Lens Nozzle Ø 12.5mm #8 53N88 Large Gas Lens Nozzle Ø 16mm #10 53N87 Large Gas Lens Nozzle Ø 19mm #12

MMA (STICK) WELDING TROUBLE SHOOTING



The following chart addresses some of the common problems of MMA welding. In all cases of equipment malfunction, the manufacturer's recommendations should be strictly adhered to and followed.

1: No arc	
<i>Possible Reason</i>	<i>Suggested Remedy</i>
Incomplete welding circuit	Check earth lead is connected. Check all cable connections.
Wrong mode selected	Check the MMA selector switch is selected
No power supply	Check that the machine is switched on and has a power supply
2: Porosity – small cavities or holes resulting from gas pockets in weld metal.	
<i>Possible Reason</i>	<i>Suggested Remedy</i>
Arc length too long	Shorten the arc length
Work piece dirty, contaminated or moisture	Remove moisture and materials like paint, grease, oil, and dirt, including mill scale from base metal
Damp electrodes	Use only dry electrodes
3: Excessive Spatter	
<i>Possible Reason</i>	<i>Suggested Remedy</i>
Amperage too high	Decrease the amperage or choose a larger electrode
Arc length too long	Shorten the arc length
4: Weld sits on top, lack of fusion	
<i>Possible Reason</i>	<i>Suggested Remedy</i>
Insufficient heat input	Increase the amperage or choose a larger electrode
Work piece dirty, contaminated or moisture	Remove moisture and materials like paint, grease, oil, and dirt, including mill scale from base metal
Poor welding technique	Use the correct welding technique or seek assistance for the correct technique
5: Lack of penetration	
<i>Possible Reason</i>	<i>Suggested Remedy</i>
Insufficient heat input	Increase the amperage or choose a larger electrode
Poor welding technique	Use the correct welding technique or seek assistance for the correct technique
Poor joint preparation	Check the joint design and fit up, make sure the material is not too thick. Seek assistance for the correct joint design and fit up
6: Excessive penetration - burn through	
<i>Possible Reason</i>	<i>Suggested Remedy</i>
Excessive heat input	Reduce the amperage or use a smaller electrode
Incorrect travel speed	Try increasing the weld travel speed
7: Uneven weld appearance	
<i>Possible Reason</i>	<i>Suggested Remedy</i>
Unsteady hand, wavering hand	Use two hands where possible to steady up, practise your technique
8: Distortion – movement of base metal during welding	
<i>Possible Reason</i>	<i>Suggested Remedy</i>
Excessive heat input	Reduce the amperage or use a smaller electrode
Poor welding technique	Use the correct welding technique or seek assistance for the correct technique
Poor joint preparation and or joint design	Check the joint design and fit up, make sure the material is not too thick. Seek assistance for the correct joint design and fit up
9: Electrode welds with different or unusual arc characteristic	
<i>Possible Reason</i>	<i>Suggested Remedy</i>
Incorrect polarity	Change the polarity, check the electrode manufacturer for correct polarity

The following chart addresses some of the common problems of MIG welding. In all cases of equipment malfunction, the manufacturer's recommendations should be strictly adhered to and followed.

1: Excessive Spatter	
Possible Reason	Suggested Remedy
Wire feed speed set too high	Select lower wire feed speed
Voltage too high	Select a lower voltage setting
Wrong polarity set	Select the correct polarity for the wire being used - see machine setup guide
Stick out too long	Bring the torch closer to the work
Contaminated base metal	Remove materials like paint, grease, oil, and dirt, including mill scale from base metal
Contaminated MIG wire	Use clean dry rust free wire. Do not lubricate the wire with oil, grease etc
Inadequate gas flow or too much gas flow	Check the gas is connected, check hoses, gas valve and torch are not restricted. Set the gas flow between 6-12 l/min flow rate. Check hoses and fittings for holes, leaks etc Protect the welding zone from wind and drafts
2: Porosity - small cavities or holes resulting from gas pockets in weld metal.	
Possible Reason	Suggested Remedy
Wrong gas	Check that the correct gas is being used
Inadequate gas flow or too much gas flow	Check the gas is connected, check hoses, gas valve and torch are not restricted. Set the gas flow between 10 - 15 l/min flow rate. Check hoses and fittings for holes, leaks etc. Protect the welding zone from wind and drafts
Moisture on the base metal	Remove all moisture from base metal before welding
Contaminated base metal	Remove materials like paint, grease, oil, and dirt, including mill scale from base metal
Contaminated MIG wire	Use clean dry rust free wire. Do not lubricate the wire with oil, grease etc
Gas nozzle clogged with spatter, worn or out of shape	Clean or replace the gas nozzle
Missing or damaged gas diffuser	Replace the gas diffuser
3: Wire stubbing during welding	
Possible Reason	Suggested Remedy
Holding the torch too far away	Bring the torch closer to the work and maintain stick out of 5-10mm
Welding voltage set too low	Increase the voltage
Wire Speed set too high	Decrease the wire feed speed
4: Lack of Fusion – failure of weld metal to fuse completely with base metal or a proceeding weld bead.	
Possible Reason	Suggested Remedy
Contaminated base metal	Remove materials like paint, grease, oil, and dirt, including mill scale from base metal
Not enough heat input	Select a higher voltage range and /or adjust the wire speed to suit
Improper welding technique	Keep the arc at the leading edge of the weld pool. Gun angle to work should be between 5 & 15° Direct the arc at the weld joint Adjust work angle or widen groove to access bottom during welding Momentarily hold arc on side walls if using weaving technique
5: Excessive Penetration – weld metal melting through base metal	
Possible Reason	Suggested Remedy
Too much heat	Select a lower voltage range and /or adjust the wire speed to suit Increase travel speed
6: Lack of Penetration – shallow fusion between weld metal and base metal	
Poor in incorrect joint preparation	Material too thick. Joint preparation and design needs to allow access to bottom of groove while maintaining proper welding wire extension and arc characteristics Keep the arc at the leading edge of the weld pool and maintain the gun angle at 5 & 15° keeping the stick out between 5-10mm
Not enough heat input	Select a higher voltage range and /or adjust the wire speed to suit Reduce travel speed
Contaminated base metal	Remove materials like paint, grease, oil, and dirt, including mill scale from base metal.

MIG WIRE FEED TROUBLE SHOOTING



The following chart addresses some of the common WIRE FEED problems during MIG welding. In all cases of equipment malfunction, the manufacturer's recommendations should be strictly adhered to and followed.

1: Inconsistent / interrupted wire feed	
Possible Reason	Suggested Remedy
Wrong polarity selected	Select the correct polarity for the wire being used - see machine setup guide
Incorrect wire speed setting	Adjust the wire feed speed
Voltage setting incorrect	Adjust the voltage setting
MIG torch lead kinked or too sharp angle being held	Remove the kink, reduce the angle or bend
Contact tip worn, wrong size, wrong type	Replace the tip with correct size and type
Liner worn or clogged (the most common causes of bad feeding)	Try to clear the liner by blowing out with compressed air as a temporary cure, it is recommended to replace the liner
Wrong size liner	Install the correct size liner
Blocked or worn inlet guide tube	Clear or replace the inlet guide tube
Wire misaligned in drive roller groove	Locate the wire into the groove of the drive roller
Incorrect drive roller size	Fit the correct size drive roller e.g.; 0.8mm wire requires 0.8mm drive roller
Wrong type of drive roller selected	Fit the correct type roller (e.g. knurled rollers needed for flux cored wires)
Worn drive rollers	Replace the drive rollers
Drive roller pressure too high	Can flatten the wire electrode causing it to lodge in the contact tip - reduce the drive roller pressure
Too much tension on wire spool hub	Reduce the spool hub brake tension
Wire crossed over on the spool or tangled	Remove the spool untangle the wire or replace the wire
Contaminated MIG wire	Use clean dry rust free wire. Do not lubricate the wire with oil, grease etc

The following chart addresses some of the common problems of TIG welding. In all cases of equipment malfunction, the manufacturer's recommendations should be strictly adhered to and followed.

1: Tungsten burning away quickly	
<i>Possible Reason</i>	<i>Suggested Remedy</i>
Incorrect Gas	Check that pure Argon is being used
No gas	Check the gas cylinder contains gas and is connected
Inadequate gas flow	Check the gas is connected, check hoses, gas valve and torch are not restricted. Set the gas flow between 10 - 15 l/min flow rate
Back cap not fitted correctly	Make sure the torch back cap is fitted so that the o-ring is inside the torch body
Torch connected to DC +	Connect the torch to the DC- output terminal
Incorrect tungsten being used	Check and change the tungsten type if necessary
Tungsten being oxidised after weld is finished	Keep shielding gas flowing 10–15 seconds after arc stoppage. 1 second for each 10 amps of weld current.
Tungsten melting back into the nozzle on AC welding	Check that correct type of tungsten is being used. Check the balance control is not set too high on the balance - reduce to a lower setting
2: Contaminated tungsten	
<i>Possible Reason</i>	<i>Suggested Remedy</i>
Touching tungsten into the weld pool	Keep tungsten from contacting weld puddle. Raise the torch so that the tungsten is off of the work piece 2 - 5mm
Touching the filler wire to the tungsten	Keep the filler wire from touching the tungsten during welding, feed the filler wire into the leading edge of the weld pool in front of the tungsten
Tungsten melting into the weld pool	Check that correct type of tungsten is being used. Too much current for the tungsten size so reduce the amps or change to a larger tungsten
3: Porosity - poor weld appearance and colour	
<i>Possible Reason</i>	<i>Suggested Remedy</i>
Incorrect Gas	Check that pure Argon is being used
Inadequate gas flow / gas leaks	Check the gas is connected, check hoses, gas valve and torch are not restricted. Set the gas flow between 10 - 15 l/min flow rate. Check hoses and fittings for holes, leaks etc.,
Moisture on the base metal	Remove all moisture from base metal before welding
Contaminated base metal	Remove materials like paint, grease, oil, and dirt, including mill scale from base metal
Contaminated filler wire	Remove all grease, oil, or moisture from filler metal.
Incorrect filler wire	Check the filler wire and change if necessary
4: Yellowish residue / smoke on the alumina nozzle & discoloured tungsten	
<i>Possible Reason</i>	<i>Suggested Remedy</i>
Incorrect Gas	Use pure Argon gas
Inadequate gas flow	Set the gas flow between 10 - 15 l/min flow rate
Inadequate post flow gas	Increase the post flow gas time
Alumina gas nozzle too small for size of tungsten being used	Increase the size of the alumina gas nozzle
5: Unstable Arc during DC welding	
<i>Possible Reason</i>	<i>Suggested Remedy</i>
Torch connected to DC +	Connect the torch to the DC- output terminal
Contaminated base metal	Remove materials like paint, grease, oil, and dirt, including mill scale from base metal.
Tungsten is contaminated	Remove 10mm of contaminated tungsten and re grind the tungsten
Arc length too long	Lower torch so that the tungsten is off of the work piece 2 - 5mm
Unstable Arc during AC welding	
Incorrect gas or inadequate gas flow	Check that pure Argon is being used. Check the gas is connected, check hoses, gas valve and torch are not restricted. Set the gas flow between 10 - 15 l/min flow rate
Incorrect tungsten being used	Check and change the tungsten type if necessary
Tungsten is contaminated	Remove 10mm of contaminated tungsten and re grind the tungsten
Improperly prepared tungsten	Use a pointed tungsten with AC Squarewave inverter machines. The point will round off after welding.
Excessive rectification in the base metal	Increase balance control. Increase travel speed. Add filler wire during welding

6: HF present but no welding power	
<i>Possible Reason</i>	<i>Suggested Remedy</i>
Incomplete welding circuit	Check earth lead is connected. Check all cable connections. If using a water cooled torch check that the power cable is not separated.
No gas	Check the gas is connected and cylinder valve open, check hoses, gas valve and torch are not restricted. Set the gas flow between 10 - 15 l/min flow rate
Tungsten melting into the weld pool	Check that correct type of tungsten is being used. Too much current for the tungsten size so reduce the amps or change to a larger tungsten
7: Arc wanders during DC welding	
<i>Possible Reason</i>	<i>Suggested Remedy</i>
Poor gas flow	Check and set the gas flow between 10 - 15 l/min flow rate
Incorrect arc length	Lower torch so that the tungsten is off of the work piece 2 - 5mm
Tungsten incorrect or in poor condition	Check that correct type of tungsten is being used. Remove 10mm from the weld end of the tungsten and re sharpen the tungsten
Poorly prepared tungsten	Grind marks should run lengthwise with tungsten, not circular. Use proper grinding method and wheel.
Contaminated base metal	Remove contaminating materials like paint, grease, oil, and dirt, including mill scale from base metal.
Contaminated filler wire	Remove all grease, oil, or moisture from filler metal.
Incorrect filler wire	Check the filler wire and change if necessary
Arc wanders during AC welding	
<i>Possible Reason</i>	<i>Suggested Remedy</i>
Inadequate gas flow	Set the gas flow between 10 - 15 l/min flow rate
Incorrect arc length	Set the torch so that the tungsten is off of the work piece 2 - 5mm
Tungsten is contaminated	Remove 10mm of contaminated tungsten and re grind the tungsten. Use a pointed tungsten with AC Squarewave and inverter machines. The point will round off after welding
Incorrect tungsten size and or tungsten being used	Check and change the size and or the tungsten if required
Excessive rectification in the base metal	Increase balance control. Increase travel speed. Add filler wire during welding
Contaminated base metal	Remove contaminating materials like paint, grease, oil, and dirt, including mill scale from base metal.
8: Arc difficult to start or will not start DC welding	
<i>Possible Reason</i>	<i>Suggested Remedy</i>
Incorrect machine set up	Check machine set up is correct
No gas, incorrect gas flow	Check the gas is connected and cylinder valve open, check hoses, gas valve and torch are not restricted. Set the gas flow between 10 - 15 l/min flow rate
Tungsten is contaminated	Remove 10mm of contaminated tungsten and re grind the tungsten
Incorrect tungsten size and or tungsten being used	Check and change the size and or the tungsten if required
Loose connection	Check all connectors and tighten
Earth clamp not connected to work	Connect the earth clamp directly to the work piece wherever possible
Loss of high frequency	Check torch and cables for cracked insulation or bad connections. Check spark gaps and adjust if necessary
Arc difficult to start or will not start AC welding	
Incorrect machine set up	Check machine set up is correct
No gas, incorrect gas flow	Check the gas is connected and cylinder valve open, check hoses, gas valve and torch are not restricted. Set the gas flow between 10 - 15 l/min flow rate
Incorrect tungsten size and or tungsten being used	Check and change the size and or the tungsten if required
Tungsten is contaminated	Remove 10mm of contaminated tungsten and re grind the tungsten. Use a pointed tungsten with AC Squarewave and inverter machines. The point will round off after welding
Loose connection	Check all connectors and tighten
Earth clamp not connected to work	Connect the earth clamp directly to the work piece wherever possible
Loss of high frequency	Check torch and cables for cracked insulation or bad connections. Check spark gaps and adjust if necessary

ESSETI New Zealand Limited ('us', 'we') warrants that the products bearing the brand names ESSETI, XCEL-ARC, RAZORWELD, RAZORCUT, JASIC, VIPER, T&R, XCEL-GAS, Otos, Servore, TECNA & HIT-8SS supplied by us and purchased by you from an Authorised ESSETI (NZ) Ltd. Distributor are free of Material and Faulty Workmanship Defects except for those products listed under 'Warranty Exclusions' and whilst any claim is made subject to the following terms and conditions.

Your rights under the New Zealand Consumer Law may not be limited by a defined time. However, New Zealand Consumer Law does recognise that the relevant time period can vary from product to product, depending on factors such as the nature of the product and the price. Esseti NZ Ltd. adopts the same approach. As you can appreciate, the type of remedy we can offer you may also vary depending on how long it takes you to return the product to us.

WARRANTY PERIOD

We offer the following 'Warranty Periods' from 'date of purchase':

An Extended Warranty Period of 6 months total shall apply only to Machinery where offered and warranty is registered online.

We offer the following 'Warranty Periods' effective from the 'date of purchase':

XCEL-ARC, Inverter MIG/SWF/MTS, MMA/TIG, TIG ACDC, Plasma (Power Source Only*)	2 Years
RAZORWELD, Inverter MIG/SWF/MTS, MMA/TIG, TIG ACDC (Power Source Only*)	3 Years
RAZORCUT, Inverter Plasma (Power Source Only*)	3 Years
VIPER MIG185, Viper TIG180ACDC (Power Source Only*)	2 Years
VIPER ARC140, VIPER ARC160, VIPER CUT30, (Power Source Only*)	1 Year
VIPER TIG200P, VIPER SYNERGIC MIG 120 (Power Source Only*)	1 Year
JASIC, Inverter MIG/SWF/MTS, MMA/TIG, TIG ACDC, Plasma (Power Source Only*)	2 Years
XCEL-ARC & RAZORWELD, Water Coolers, PAPR Air Blower Unit	1 Year
XCEL-GAS, Gas Cutting and Welding Torches	3 Months
XCEL-GAS, Straight Line & Gas Cutting Machines (Machine Only*)	1 Year
XCEL-GAS, Regulators Argon/ Acetylene / Oxygen / LPG / Bobbin Flowmeter	1 Year
XCEL-ARC, Automatic Welding Helmet	2 Years
RAZORSHIELD Digital Welding Mask & Goggle Kit , Automatic Welding Helmets	2 Year
TECNA, Spot Welding Machines (Power Source Only*)	1 Year
ALL WELDING TORCHES – GMAW / GTAW / MMAW / PLASMA	3 Months
ALL EARTH LEADS, INTERCONNECTING CABLES, GAS HOSES	3 Months

(*) This only covers manufacturing faults on any torches, cables and other accessories, either included with a machine kitset or sold separately, for the first three months after date of purchase.

WARRANTY / RETURNS / EXCHANGES

Our Warranty Returns Policy recognises all and any rights you have under New Zealand Consumer Law and other relevant laws.

You shall inspect the goods on delivery and shall within seven (7) days of delivery (time being of the essence) notify the Esseti NZ Ltd. Authorised Distributor from whom you purchased the goods of any alleged defect, shortage in quantity, damage or failure to comply with the description or quote.

You shall also afford Esseti NZ Ltd. the opportunity to inspect the goods within a reasonable time following delivery if you believe the goods are defective in any way.

If you shall fail to comply with these provisions the goods shall be presumed to be free from any defect or damage. For defective goods and where permissible by law, Esseti NZ Ltd. reserves the right to repair or otherwise remedy the defect prior to issuing replacement goods or refunding the purchase price.

If the goods are being purchased for a business purpose then the purchaser acknowledges that the Consumer Guarantees Act will not apply.

The New Zealand Sales of Goods Act applies when goods are not covered by the Consumer Guarantees Act. You may be able to get a full refund or compensation if the trader doesn't have the right to sell the goods, or the goods are:

- not of 'merchantable quality' (so defective that most people wouldn't want them)
- not fit for their normal purpose
- poorer quality than a sample you were shown
- not suitable for what you told the trader you wanted the goods for
- not matching their description

If there has been a misrepresentation you may have rights under the Fair Trading Act or the Contractual Remedies Act and therefore also entitled to, at the consumer's discretion, either a refund of the purchase price of the goods, or repair of the goods, or replacement of the goods.

Returns will only be accepted provided that:

- (a) You have complied with the provisions outlined above, and
- (b) where the goods are unable to be repaired, the goods are returned at your cost within thirty (30) days of the delivery date, and
- (c) Esseti NZ Ltd. will not be liable for goods which have not been stored or used in a proper manner, and
- (d) the goods are returned in the condition in which they were delivered and with all packaging material, brochures and instructional material in as new condition as is reasonably possible in the circumstances.

Esseti NZ Ltd Accepts no responsibility for any products lost, damaged or mislaid whilst in transit. Esseti NZ Ltd. may (at their sole discretion) accept the return of goods for credit but this may incur a handling fee of up to fifteen percent (15%) of the value of the returned Goods plus any freight costs.

MAKING A CLAIM

If you wish to make a claim under this Warranty, you should:

- Return the product to the point of purchase either in person or via prepaid courier; or
- Contact us by Telephone – Esseti NZ Ltd – 06 355 1103

When returned, the product must be accompanied with the original Receipt or Tax Invoice clearly showing the purchase date and disclosing the purchase price. All costs of installation, cartage, freight, travelling expenses, hiring tools and insurance are paid by the Customer. To the extent permitted by law, our total liability for loss or damage of every kind related to the goods in any way whatsoever is limited to the amount paid to the retailer by you for the goods or the value of the goods. No responsibility will be taken for any products lost, damaged or mislaid whilst in transit.

WARRANTY EXCLUSIONS

This Warranty covers Material and Faulty Workmanship defects only.

This Warranty does not cover damage caused by:

- Normal wear and tear due to usage
- Misuse or abusive use of the machine and/or failure to correctly follow set up or operating instructions supplied with these products
- Failure to clean or improper cleaning of the product
- Failure to maintain the equipment such as regular services, etc.
- Incorrect voltage or non-authorized electrical connections
- Improper installation
- Use of non-authorized/non-standard parts
- Abnormal product performance caused by any ancillary equipment interference or other external factors
- Failure or any breakage caused by overload, dropping or abusive treatment or use by the customer
- Repair, modifications or other work carried out on the product other than by an Esseti-Authorised Service Agent

Unless it is a manufacturing fault, this Warranty does not cover the following parts:

• **All Batteries, including Button Type and Cell Type Batteries**

• **MIG Welding Torch Consumables, such as:**

Gas Nozzles, Gas Diffusers, Contact Tip Holders, Contact Tips, Swan Necks, Triggers, Handles, Liners, Euro Block, Shroud Springs, Knobs, All XCEL-ARC / Magmaweld Mig Welding Wires & Electrodes, Arc Leads, Welding Cable, Electrode Holder, Earth Clamps

• **MMA & TIG Welding Torch Consumables, such as:**

Tungsten Electrodes, Collet, Collet Body, Alumina Nozzle, Torch Head, Torch Head water Cooled, Torch Head Flexible, Back Caps, Gas Lens, Torch Handle, Cup Gasket, Torch Body Gas Valve, O-ring, All XCEL-ARC TIG Welding Rods, All XCEL-ARC / Magmaweld Electrodes, Arc Leads, Welding Cable, Electrode Holder, Earth Clamps

• **PLASMA Cutting Torches Consumables, such as:**

All Cutting Tips, All Diffuser/Swirl Ring, All Electrodes, Retaining Caps, Nozzle Springs, All Spacers, All Shield Caps, All Air and Power Cables, All Switches, All O-rings, All Springs, All Circle Guides and Cutting Kits, Torch Bodies, Air Filter Regulator, Welding Cable, Earth Clamps

• **Gas Welding & Cutting Torch and Straight Line Cutting Machine Consumables and Fittings, such as:**

All Cutting, Welding & Brazing Tips, Adaptors, Hoses, Fittings, Tracks and associated parts

• **Automatic Welding & Cutting Carriage Machine Parts, such as:**

Input Cord, Inter-connecting Power Cord, Triggering Cable

This Warranty does not cover products purchased:

- Without the provision of a suitable Receipt or Tax Invoice that clearly provides proof of purchase as outlined above
- At an auction or from a private seller
- Unless it is a manufacturing fault, this Warranty does not apply to any products sold to Hire Companies.

These conditions may only be varied with the written approval of the Directors of Esseti NZ Limited.

REMEMBER TO RETAIN YOUR ORIGINAL INVOICE FOR PROOF OF PURCHASE.

NOTES



A series of horizontal dotted lines for taking notes.



Esseti New Zealand Limited
PO Box 4189, Palmerston North - 4442
Phone: 06 355 1103
Fax: (06) 354 2437
Email: sales@esseti.co.nz
www.esseti.co.nz