

RAZORWELD ARC 630



630A MMA/CAG/TIG INVERTER WELDER

XA-ARC630RZ | Operating Manual



Please read and understand this instruction manual carefully before the installation and operation of this equipment.

© Xcel-Arc 2023



CONTENTS



WARRANTY.....	3
SAFETY.....	4
RAZORWELD ARC 630 FEATURES.....	7
INSTALLATION SET UP FOR MMA (STICK) WELDING.....	11
MMA(STICK) WELDING GUIDE.....	12
INSTALLATION SET UP FOR DC TIG WELDING.....	15
TIG WELDING GUIDE.....	17
ARC-AIR GOUGING SET UP.....	22
ARC-AIR GOUGING GUIDE.....	24
XA26V TIG TORCH & SPARES (OPTIONAL).....	26
ARC AIR GOUGING TORCH, DC CARBONS (OPTIONAL).....	28
GAS FLOW REGULATORS - SHEILDING GASES.....	29
MMA (STICK) WELDING TROUBLE SHOOTING.....	30
LIST OF ERROR CODES.....	32
WARRANTY TERMS.....	33



**REGISTER YOUR MACHINE ONLINE TO RECEIVE AN
ADDITIONAL 6 MONTHS ON YOUR WARRANTY**

Visit [XcelArc.nz/warranty-registration/](https://www.XcelArc.nz/warranty-registration/) to register your machine.

Thank you for your purchase of your RAZORWELD ARC Welding Machine.

We are proud of our range of welding equipment that has a proven track record of innovation, performance and reliability.

Our product range represents the latest developments in Inverter technology put together by our professional team of highly skilled engineers. The expertise gained from our long involvement with inverter technology has proven to be invaluable towards the evolution and future development of our equipment range. This experience gives us the inside knowledge on what the arc characteristics, performance and interface between man and machine should be.

Within our team are specialist welders that have a proven history of welding knowledge and expertise, giving vital input towards ensuring that our machines deliver control and performance to the utmost professional level.

We employ an expert team of professional sales, marketing and technical personnel that provide us with market trends, market feedback and customer comments and requirements. Secondly they provide a customer support service that is second to none, thus ensuring our customers have confidence that they will be well satisfied both now and in the future.

Xcel-Arc welders and plasma cutters are manufactured to be compliant with - AS/NZ 60974-1, guaranteeing you electrical safety and performance.

WARRANTY

- 3 Years from date of purchase.
- ESSETI New Zealand Limited warranties all goods as specified by the manufacturer of those goods.
- This Warranty does not cover freight or goods that have been interfered with.
- All goods in question must be repaired by an authorised repair agent as appointed by this company.
- Warranty does not cover abuse, misuse, accident, theft, general wear and tear.
- New product will not be supplied unless ESSETI New Zealand Limited has inspected product returned for warranty and agrees to replace product.
- Product will only be replaced if repair is not possible
- Please view full Warranty term and conditions supplied with machine or at www.XcelArc.nz/warranty-terms/ or at the back of this manual.

ATTENTION! - CHECK FOR GAS LEAKAGE

At initial set up and at regular intervals we recommend to check for gas leakage

Recommended procedure is as follows:

1. Connect the regulator and gas hose assembly and tighten all connectors and clamps.
2. Slowly open the cylinder valve.
3. Set the flow rate on the regulator to approximately 8-10 L/min.
4. Close the cylinder valve and pay attention to the needle indicator of the contents pressure gauge on the regulator, if the needle drops away towards zero there is a gas leak. Sometimes a gas leak can be slow and to identify it will require leaving the gas pressure in the regulator and line for an extended time period. In this situation it is recommended to open the cylinder valve, set the flow rate to 8-10 L/min, close the cylinder valve and check after a minimum of 15 minutes.
5. If there is a gas loss then check all connectors and clamps for leakage by brushing or spraying with soapy water, bubbles will appear at the leakage point.
6. Tighten clamps or fittings to eliminate gas leakage.

IMPORTANT! - We strongly recommend that you check for gas leaks prior to operation of your machine. We recommend that you close the cylinder valve when the machine is not in use.

Esseti NZ Ltd, authorised representatives or agents of Esseti NZ Ltd will not be liable or responsible for the loss of any gas.

Welding and cutting equipment can be dangerous to both the operator and people in or near the surrounding working area, if the equipment is not correctly operated. Equipment must only be used under the strict and comprehensive observance of all relevant safety regulations.

Read and understand this instruction manual carefully before the installation and operation of this equipment.

Machine Operating Safety

- Do not switch the function modes while the machine is operating. Switching of the function modes during welding can damage the machine. Damage caused in this manner will not be covered under warranty.
- Disconnect the electrode-holder cable from the machine before switching on the machine, to avoid arcing should the electrode be in contact with the work piece.
- Operators should be trained and or qualified.



Electric shock: It can kill. Touching live electrical parts can cause fatal shocks or severe burns. The electrode and work circuit is electrically live whenever the output is on. The input power circuit and internal machine circuits are also live when power is on. In MIG/MAG welding, the wire, drive rollers, wire feed housing, and all metal parts touching the welding wire are electrically live. Incorrectly installed or improperly grounded equipment is dangerous.

- Connect the primary input cable according to Australian and New Zealand standards and regulations.
- Avoid all contact with live electrical parts of the welding/cutting circuit, electrodes and wires with bare hands.
- The operator must wear dry welding gloves while he/she performs the welding/cutting task.
- The operator should keep the work piece insulated from himself/herself.
- Keep cords dry, free of oil and grease, and protected from hot metal and sparks.
- Frequently inspect input power cable for wear and tear, replace the cable immediately if damaged, bare wiring is dangerous and can kill.
- Do not use damaged, under sized, or badly joined cables.
- Do not drape cables over your body.
- We recommend (RCD) safety switch is used with this equipment to detect any leakage of current to earth.



Fumes and gases are dangerous. Smoke and gas generated whilst welding or cutting can be harmful to people's health. Welding produces fumes and gases. Breathing these fumes and gases can be hazardous to your health.

Do not breathe the smoke and gas generated whilst welding or cutting, keep your head out of the fumes

- Keep the working area well ventilated, use fume extraction or ventilation to remove welding/cutting fumes and gases.
- In confined or heavy fume environments always wear an approved air-supplied respirator.
- Welding/cutting fumes and gases can displace air and lower the oxygen level causing injury or death. Be sure the breathing air is safe.
- Do not weld/cut in locations near de-greasing, cleaning, or spraying operations. The heat and rays of the arc can react with vapours to form highly toxic and irritating gases.
- Materials such as galvanized, lead, or cadmium plated steel, containing elements that can give off toxic fumes when welded/cut. Do not weld/cut these materials unless the area is very well ventilated, and or wearing an air supplied respirator.



Arc rays: harmful to people's eyes and skin. Arc rays from the welding/cutting process produce intense visible and invisible ultraviolet and infrared rays that can burn eyes and skin.

Always wear a welding helmet with correct shade of filter lens and suitable protective clothing including welding gloves whilst the welding/cutting operation is performed.

- Measures should be taken to protect people in or near the surrounding working area. Use protective screens or barriers to protect others from flash, glare and sparks; warn others not to watch the arc.



Fire hazard. Welding/cutting on closed containers, such as tanks, drums, or pipes, can cause them to explode. Flying sparks from the welding/cutting arc, hot work piece, and hot equipment can cause fires and burns. Accidental contact of electrode to metal objects can cause sparks, explosion, overheating, or fire. Check and be sure the area is safe before doing any welding/cutting.

- The welding/cutting sparks & spatter may cause fire, therefore remove any flammable materials well away from the working area. Cover flammable materials and containers with approved covers if unable to be moved from the welding/cutting area.
- Do not weld/cut on closed containers such as tanks, drums, or pipes, unless they are properly prepared according to the required Safety Standards to insure that flammable or toxic vapours and substances are totally removed, these can cause an explosion even though the vessel has been "cleaned". Vent hollow castings or containers before heating, cutting or welding. They may explode.
- Do not weld/cut where the atmosphere may contain flammable dust, gas, or liquid vapours (such as petrol)
- Have a fire extinguisher nearby and know how to use it. Be alert that welding/cutting sparks and hot materials from welding/cutting can easily go through small cracks and openings to adjacent areas. Be aware that welding/cutting on a ceiling, floor, bulkhead, or partition can cause fire on the hidden side.



Gas Cylinders. Shielding gas cylinders contain gas under high pressure. If damaged, a cylinder can explode. Because gas cylinders are normally part of the welding/cutting process, be sure to treat them carefully. CYLINDERS can explode if damaged.

- Protect gas cylinders from excessive heat, mechanical shocks, physical damage, slag, open flames, sparks, and arcs.
- Insure cylinders are held secure and upright to prevent tipping or falling over.
- Never allow the welding/cutting electrode or earth clamp to touch the gas cylinder, do not drape welding cables over the cylinder.
- Never weld/cut on a pressurised gas cylinder, it will explode and kill you.
- Open the cylinder valve slowly and turn your face away from the cylinder outlet valve and gas regulator.



Gas build up. The build up of gas can causes a toxic environment, deplete the oxygen content in the air resulting in death or injury. Many gases use in welding/cutting are invisible and odourless.

- Shut off shielding gas supply when not in use.
- Always ventilate confined spaces or use approved air-supplied respirator.



Electronic magnetic fields. MAGNETIC FIELDS can affect Implanted Medical Devices.

- Wearers of Pacemakers and other Implanted Medical Devices should keep away.
- Implanted Medical Device wearers should consult their doctor and the device manufacturer before going near any electric welding, cutting or heating operation.



Noise can damage hearing. Noise from some processes or equipment can damage hearing.

- Wear approved ear protection if noise level is high.



Hot parts. Items being welded/cut generate and hold high heat and can cause severe burns.

Do not touch hot parts with bare hands. Allow a cooling period before working on the welding/cutting gun. Use insulated welding gloves and clothing to handle hot parts and prevent burns.

CAUTION

1. Working Environment.

- i. The environment in which this welding/cutting equipment is installed must be free of grinding dust, corrosive chemicals, flammable gas or materials etc, and at no more than maximum of 80% humidity.
- ii. When using the machine outdoors protect the machine from direct sun light, rain water and snow etc; the temperature of working environment should be maintained within -10°C to +40°C.
- iii. Keep this equipment 30cm distant from the wall.
- iv. Ensure the working environment is well ventilated.

2. Safety Tips.

i. Ventilation

This equipment is small-sized, compact in structure, and of excellent performance in amperage output. The fan is used to dissipate heat generated by this equipment during the welding/cutting operation. Important: Maintain good ventilation of the louvres of this equipment. The minimum distance between this equipment and any other objects in or near the working area should be 30 cm. Good ventilation is of critical importance for the normal performance and service life of this equipment.

ii. Thermal Overload protection.

Should the machine be used to an excessive level, or in high temperature environment, poorly ventilated area or if the fan malfunctions the Thermal Overload Switch will be activated and the machine will cease to operate. Under this circumstance, leave the machine switched on to keep the built-in fan working to bring down the temperature inside the equipment. The machine will be ready for use again when the internal temperature reaches safe level.

iii. Over-Voltage Supply

Regarding the power supply voltage range of the machine, please refer to "Main parameter" table. This equipment is of automatic voltage compensation, which enables the maintaining of the voltage range within the given range. In case that the voltage of input power supply amperage exceeds the stipulated value, it is possible to cause damage to the components of this equipment. Please ensure your primary power supply is correct.

- iv. Do not come into contact with the output terminals while the machine is in operation. An electric shock may possibly occur.

MAINTENANCE

Exposure to extremely dusty, damp, or corrosive air is damaging to the welding/cutting machine. In order to prevent any possible failure or fault of this welding/cutting equipment, clean the dust at regular intervals with clean and dry compressed air of required pressure.

Please note that: lack of maintenance can result in the cancellation of the guarantee; the guarantee of this welding/cutting equipment will be void if the machine has been modified, attempt to take apart the machine or open the factory-made sealing of the machine without the consent of an authorized representative of the manufacturer.

TROUBLE SHOOTING

Caution: Only qualified technicians are authorized to undertake the repair of this welding/cutting equipment. For your safety and to avoid Electrical Shock, please observe all safety notes and precautions detailed in this manual.

INSTALLATION & OPERATION

Please install the machine strictly according to the steps. The protection class of this machine is IP21S, so avoid using it in rain.

CONNECTION OF INPUT CABLES

Primary input cable is supplied with this welding equipment. Connect the primary input cable with power supply of required input voltage. Refer to data plate on machine for Input voltage, IMAX and IEFF.

EMC DECLARATION

IEC 60974-10:2007

Arc Welding equipment - Part 10: Electromagnetic compatibility (EMC) requirements (Classification of ISM Equipment - According to IEC 60974-10:2007 and CISPR 11: 2033+A1:2004 Clause 4.1 and 4.2. The EUT Belongs to Apparatus Group2 Class A)

RAZORWELD ARC 630 FEATURES

RAZORWELD
ARC630

Welds: Steels, Stainless, Cast Iron, Bronze, Copper

RAZORWELD ARC630

230V 3-Phase 630 Amp DC Welder MMA/CAG/TIG
Selectable VRD - Stick Electrode, Lift Arc DC TIG



Features

- New MCU control system
- MMA (stick electrode)
 - Selectable On/Off VRD (Voltage Reduction Device)
 - Hot start (improves electrode starting)
 - Arc Force (boosts current to prevent electrode extinguishing)
 - Excellent arc stability with all electrodes
- DC-TIG
 - Lift Arc ignition (prevents tungsten sticking during arc ignition)
 - Ultra smooth DC-TIG welding current
- Arc Air Gouging Mode with High OCV
- Thermal overload protection
- Generator compatible
- Tolerant to variable power supply



XA-ARC630RZ-K
Standard Package



Optional machine accessories available - www.xcelarc.nz

Technical Data

Power Supply	415V 3-Phase $\pm 10\%$
I _{eff} MMA	31.0 Amps
TIG	31.6 Amps
I Max MMA	62.0 Amps
TIG	50.0 Amps
Welding Current Range	20 ~ 630 Amps
No Load Voltage (OCV)	90V
Duty Cycle @ 40°C as per AS/NZ60974-1	25% @ 630A MMA 100% @ 315A MMA 40% @ 630A TIG 100% @ 400A TIG
Power Factor	0.7
Efficiency	≥ 80
Electrode Diameter	$\phi 1.6 \sim \phi 6.0$
Protection Class	IP21S
Insulation Class	H
Cooling	AF
Dimensions (LxWxH)	550 x 240 x 445mm
Weight	33.5kg
Certification Approval	AS/NZ60974-1

Overview

The **RazorWeld ARC630** is a superior quality inverter welding machine from Xcel-Arc. Its primary function is DC-MMA (Stick) welding, and it also offers DC-TIG capabilities with Lift-Arc Ignition. This advanced welding machine utilizes the latest generation MCU control system, resulting in exceptional arc characteristics and high reliability. Moreover, it is sturdy and portable. The DC-MMA welding function produces a smooth and stable arc, enabling high-quality welds for a variety of materials, including cast iron, stainless steel, and low hydrogen. Additionally, the inclusion of Hot-Start and Arc Force, combined with Selectable VRD, makes it perfect for on-site work, making it an excellent choice for professionals and contractors alike. The **Carbon Arc Gouging** feature is a new addition to the machine, making it perfect for weld removal, crack removal, back gouging, and weld defect repairs for carbon steels, alloy steels, stainless steels, and non-ferrous materials. The machine's optional XA26V Tig Torch provides high level DC-TIG welding of steel, stainless steel, bronze, and copper. The Lift-Arc TIG function is exceptional and delivers perfect arc ignition every time without any sticking or inclusion of the tungsten electrode to the workpiece. It produces high-quality TIG welds with remarkable smoothness and stability.

The ARC630RZ is a highly versatile machine suitable for a wide range of applications, including medium to heavy industrial use, site welding, farming, and general repair and maintenance work. Its compact design offers great portability without sacrificing power. Furthermore, it is built to specifications and complies with AS/NZ60974-1 manufacturing standards. Overall, the RazorWeld ARC630RZ is a remarkable machine that offers superior performance, reliability, and portability for all welding needs.

Product Code: XA-ARC630RZ-K

Standard Package includes: ARC630RZ Machine and Manual

Earth Lead & Arc Lead are optional

MACHINE PARTS LAYOUT



FRONT PANEL MACHINE LAYOUT:

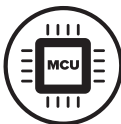
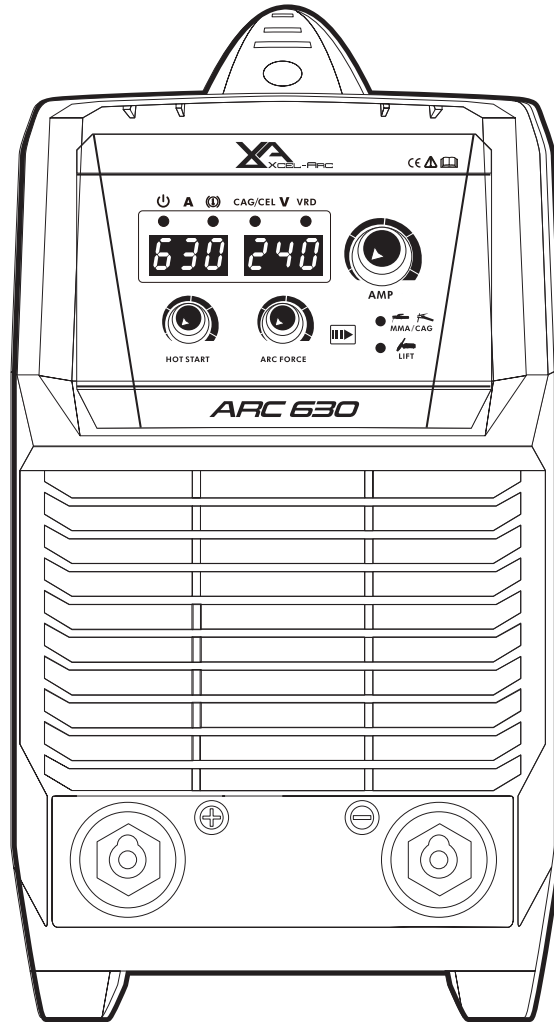

MCU CONTROL SYSTEM



THERMAL OVERLOAD PROTECTION



SWITCHABLE VRD



ARC AIR CAPABLE (CAG)



PHASE LOSS PROTECTION



3-PHASE 415V

FRONT AND REAR PANEL LAYOUT:

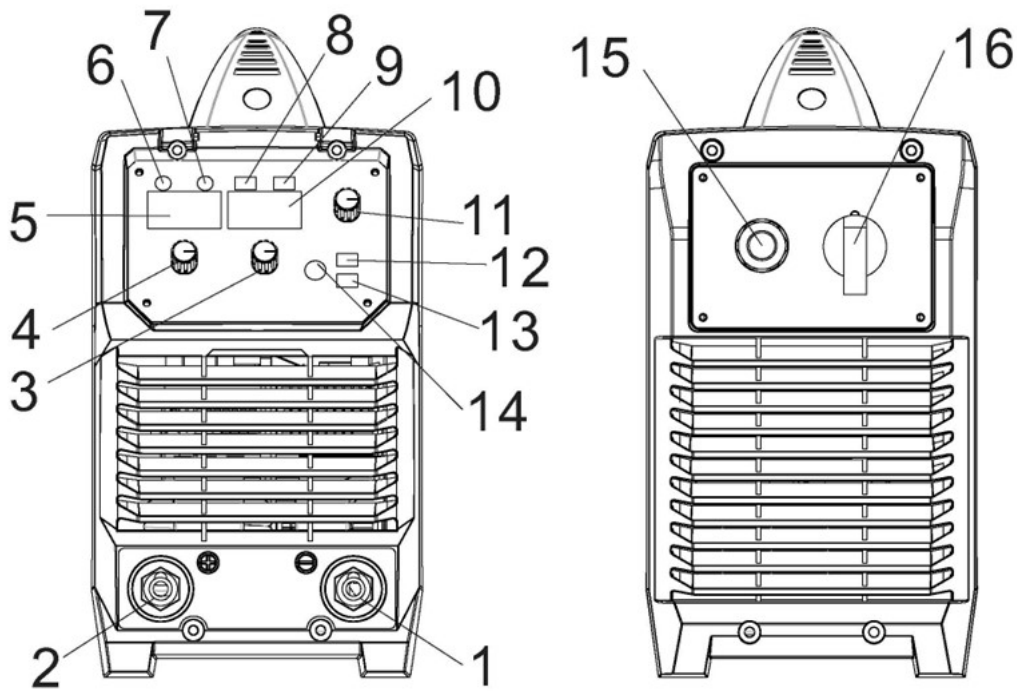

(1)“-” Output terminal.

(2)“+” Output terminal.

(3)Arc force adjust

(4)Hot start adjust

(5)Current Display

(6)Alarm indicator

(7)Power Indicator:Lights when

input power connected and

machine switched on.

(8)CAG/CEL function

(9)VRD Function

(10)Voltage Display

(11)Parameter select/adjust knob.

(12)MMA Function

(13)TIG Function

(14)Switch the MMA and TIG function

(15)Power Access client: access to cable.

(16)Power switch: control power through and break.



INSTALLATION SET UP FOR MMA (STICK) WELDING

- (1) Turn the power source on and select the **MMA** function with the Tig/MMA selector switch.
- (2) **Connection of Output Cables:** Various electrodes require a different polarity for optimum results refer to the electrode manufacturers information for the correct polarity. Most GP electrodes are Electrode connected to \ominus output socket, Earth Connected to the \oplus output socket
- (3) Set the welding current relevant to the electrode type and size being used as recommended by the electrode manufacturer.
- (4) Place the electrode into the electrode holder and clamp tight
- (5) Strike the electrode on the work to create the arc and hold the electrode steady to maintain the arc
- (6) Hold the electrode slightly above the work piece to maintain the arc while travelling at an even speed to create and even weld deposition
- (7) To finish the weld, break the arc by quickly snapping the electrode away from the work piece.
- (8) Wait for the weld to cool and carefully chip away the slag to reveal the weld metal underneath

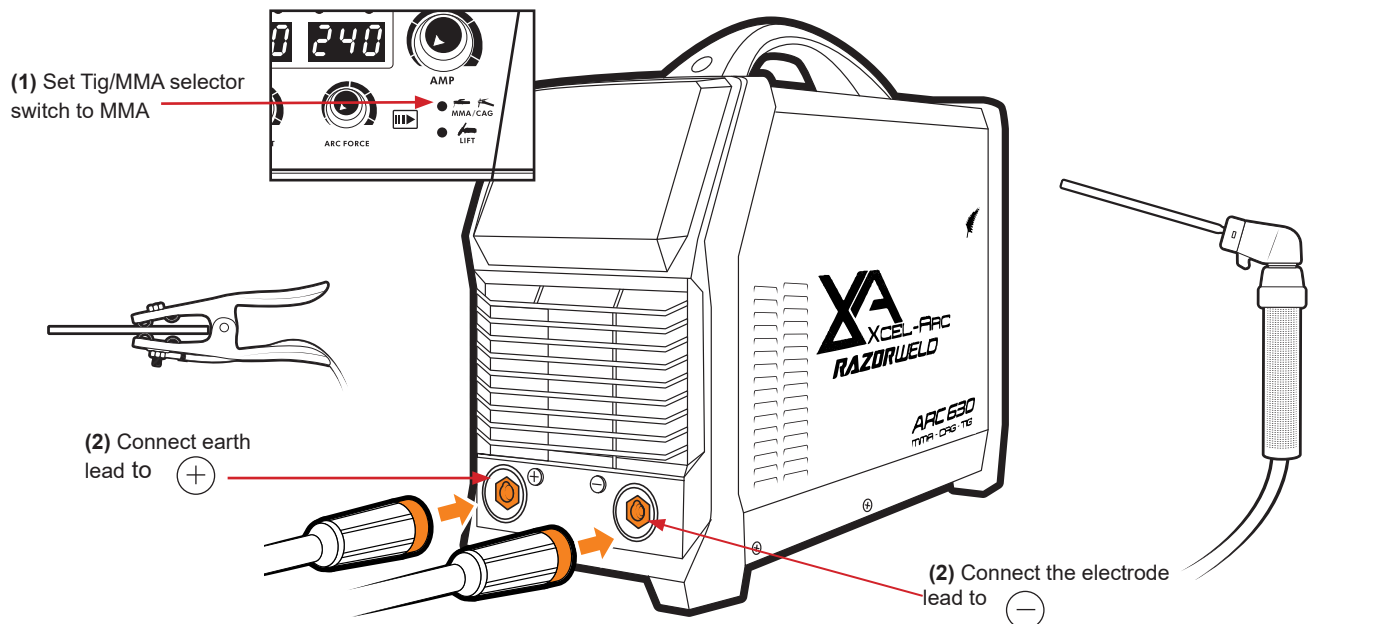

(3) Set the welding current using the amperage control dial



(4) Place the electrode into the electrode holder and clamp tight.



(5) Strike the electrode against the work piece to create and arc and hold the electrode steady to maintain the arc



(6) Hold the electrode slightly above the work maintaining the arc while travelling at an even speed.



(7) To finish the weld, break the arc by quickly snapping the electrode away from the work piece.

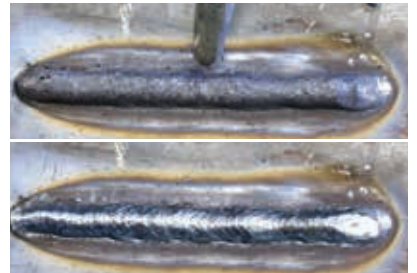

(8) Wait for the weld to cool and carefully chip away the slag to reveal the weld metal below.

MMA(STICK) WELDING GUIDE



MMA (Manual Metal Arc) Welding

One of the most common types of arc welding is manual metal arc welding (MMA) or stick welding. An electric current is used to strike an arc between the base material and a consumable electrode rod or 'stick'. The electrode rod is made of a material that is compatible with the base material being welded and is covered with a flux that gives off gaseous vapours that serve as a shielding gas and providing a layer of slag, both of which protect the weld area from atmospheric contamination. The electrode core itself acts as filler material the residue from the flux that forms a slag covering over the weld metal must be chipped away after welding.

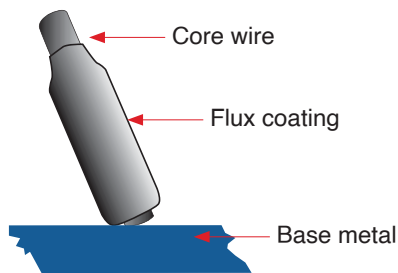
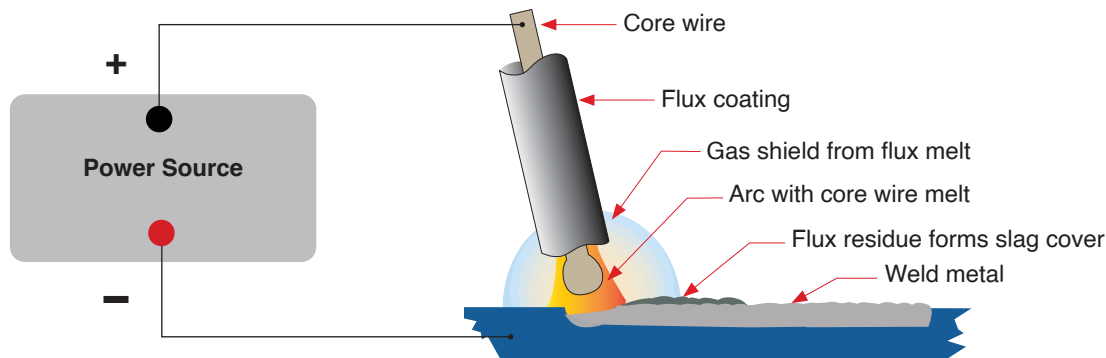

- The arc is initiated by momentarily touching the electrode to the base metal.
- The heat of the arc melts the surface of the base metal to form a molten pool at the end of the electrode.
- The melted electrode metal is transferred across the arc into the molten pool and becomes the deposited weld metal.
- The deposit is covered and protected by a slag which comes from the electrode coating.
- The arc and the immediate area are enveloped by an atmosphere of protective gas

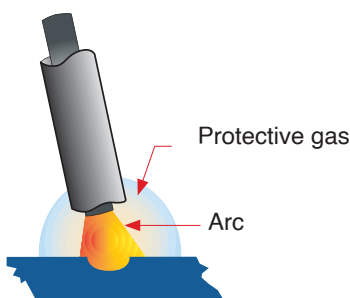

Manual metal arc (stick) electrodes have a solid metal wire core and a flux coating. These electrodes are identified by the wire diameter and by a series of letters and numbers. The letters and numbers identify the metal alloy and the intended use of the electrode.

The **Metal Wire Core** works as conductor of the current that maintains the arc. The core wire melts and is deposited into the welding pool.

The covering on a shielded metal arc welding electrode is called **Flux**. The flux on the electrode performs many different functions. These include:

- producing a protective gas around the weld area
- providing fluxing elements and deoxidizers
- creating a protective slag coating over the weld as it cools
- establishing arc characteristics
- adding alloying elements.

Covered electrodes serve many purposes in addition to adding filler metal to the molten pool. These additional functions are provided mainly by the covering on the electrode.

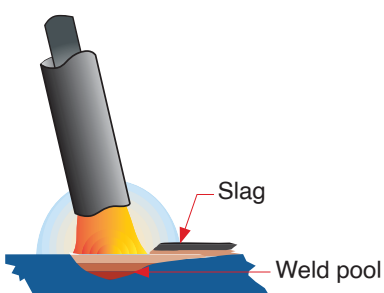

MMA (Stick) Welding Fundamentals

Electrode Selection

As a general rule, the selection of an electrode is straight forward, in that it is only a matter of selecting an electrode of similar composition to the parent metal. However, for some metals there is a choice of several electrodes, each of which has particular properties to suit specific classes of work. It is recommended to consult your welding supplier for the correct selection of electrode.

Electrode Size

Average Thickness of Material	Maximum Recommended Electrode Diameter
1.0 - 2.0mm	2.5mm
2.0 - 5.0mm	3.2mm
5.0 - 8.0mm	4.0mm
8.0 - > mm	5.0mm

The size of the electrode generally depends on the thickness of the section being welded, and the thicker the section the larger the electrode required. The table gives the maximum size of electrodes that may be used for various thicknesses of section based on using a general purpose type 6013 electrode.

Welding Current (Amperage)

Electrode Size ø mm	Current Range (Amps)
2.5mm	60 - 95
3.2mm	100 - 130
4.0mm	130 - 165
5.0mm	165 - 260

Correct current selection for a particular job is an important factor in arc welding. With the current set too low, difficulty is experienced in striking and maintaining a stable arc. The electrode tends to stick to the work, penetration is poor and beads with a distinct rounded profile will be deposited. Too high current is accompanied by overheating of the electrode resulting in undercut and burning through of the base metal and producing

excessive spatter. Normal current for a particular job may be considered as the maximum, which can be used without burning through the work, overheating the electrode or producing a rough spattered surface. The table shows current ranges generally recommended for a general purpose type 6013 electrode.

Arc Length

To strike the arc, the electrode should be gently scraped on the work until the arc is established. There is a simple rule for the proper arc length; it should be the shortest arc that gives a good surface to the weld. An arc too long reduces penetration, produces spatter and gives a rough surface finish to the weld. An excessively short arc will cause sticking of the electrode and result in poor quality welds. General rule of thumb for down hand welding is to have an arc length no greater than the diameter of the core wire.

Electrode Angle

The angle that the electrode makes with the work is important to ensure a smooth, even transfer of metal. When welding in down hand, fillet, horizontal or overhead the angle of the electrode is generally between 5 and 15 degrees towards the direction of travel. When vertical up welding the angle of the electrode should be between 80 and 90 degrees to the work piece.

Travel Speed

The electrode should be moved along in the direction of the joint being welded at a speed that will give the size of run required. At the same time, the electrode is fed downwards to keep the correct arc length at all times. Excessive travel speeds lead to poor fusion, lack of penetration etc, while too slow a rate of travel will frequently lead to arc instability, slag inclusions and poor mechanical properties.

Material and Joint Preparation

The material to be welded should be clean and free of any moisture, paint, oil, grease, mill scale, rust or any other material that will hinder the arc and contaminate the weld material. Joint preparation will depend on the method used include sawing, punching, shearing, machining, flame cutting and others. In all cases edges should be clean and free of any contaminants. The type of joint will be determined by the chosen application.



INSTALLATION SET UP FOR DC TIG WELDING

RAZORWELD
ARC630

- (1) Switch on the machine, select the **TIG** function with the Tig/MMA selector switch.
- (2) Insert the power cable plug of the Tig torch into the **Negative** socket on the front of the machine and tighten it.
- (3) Insert the earth cable plug into the **Positive** socket on the front of the machine and tighten it.
- (4) Connect the gas line of the Tig torch to regulator and connect the regulator to the gas cylinder.

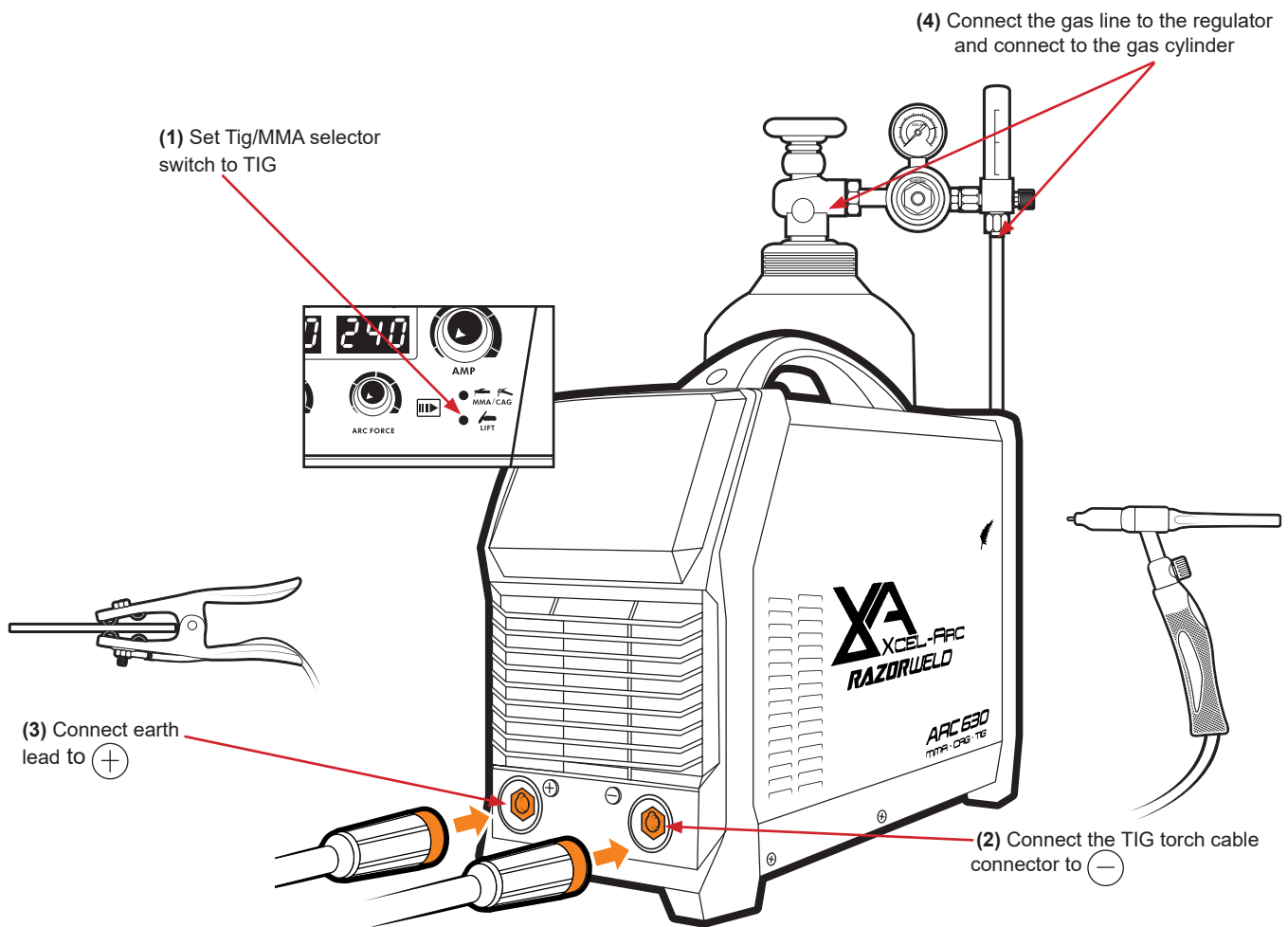

(1) Set Tig/MMA selector switch to TIG

(4) Connect the gas line to the regulator and connect to the gas cylinder

(3) Connect earth lead to (+)

(2) Connect the TIG torch cable connector to (-)



(5) Assemble front end parts of the TIG torch, fitting a sharpened tungsten suitable for DC welding.



(6) Carefully open the valve of the gas cylinder, set the l/min to 6-12



(7) Set the welding current using the amperage control dial

LIFT ARC DC TIG OPERATION



Lift Arc ignition allows the arc to be started easily in DC Tig by simply touching the tungsten to the work piece and lifting it up to start the arc. This prevents the tungsten tip sticking to the work piece and breaking the tip from the tungsten electrode. There is a particular technique called “rocking the cup” used in the Lift Arc process that provides easy use of the Lift Arc function.

- (8) Make sure the front end parts of the tig torch are correctly assembled, use the correct size and type of tungsten electrode for the job, the tungsten electrode requires a sharpened point for DC welding.
- (9) Turn on the Gas Valve located on the tig torch handle.
- (10) Lay the outside edge of the Gas Cup on the work piece with the Tungsten Electrode 1- 2mm from the work piece.
- (11) With a small movement rotate the Gas Cup forward so that the Tungsten Electrode touches the work piece.
- (12) Now rotate the Gas Cup in the reverse direction to lift the Tungsten electrode from the work piece to create the arc.



(8) Assemble front end parts of the TIG torch, fitting a sharpened tungsten suitable for DC welding.

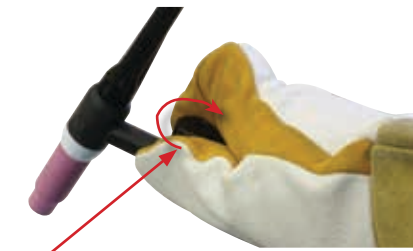

(9) Turn on the Gas Valve



(10) Lay the outside edge of the Gas Cup on the work piece with the Tungsten Electrode 1- 2mm from the work piece.



(11) With a small movement rotate the Gas Cup forward so that the Tungsten Electrode touches the work piece.

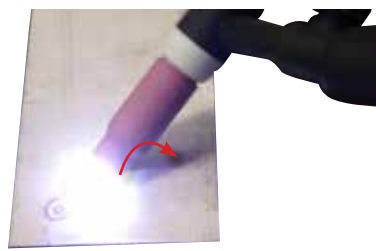

(12) Now rotate the Gas Cup in the reverse direction to lift the Tungsten electrode from the work piece to create the arc.

IMPORTANT! - We strongly recommend that you check for gas leakage prior to operation of your machine. We recommend that you close the cylinder valve when the machine is not in use.

Esseti NZ Ltd, authorised representatives or agents of Esseti NZ Ltd will not be liable or responsible for the loss of any gas.

DC TIG Welding

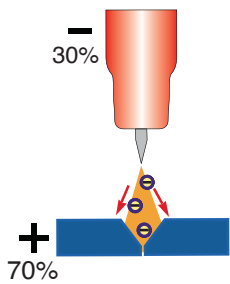

The DC power source uses what is known as DC (direct current) in which the main electrical component known as electrons flow in only one direction from the negative pole (terminal) to the positive pole (terminal). In the DC electrical circuit there is an electrical principle at work which should always be taken into account when using any DC circuit. With a DC circuit 70% of the energy (heat) is always on the positive side. This needs to be understood because it determines what terminal the TIG torch will be connected to (this rule applies to all the other forms of DC welding as well).

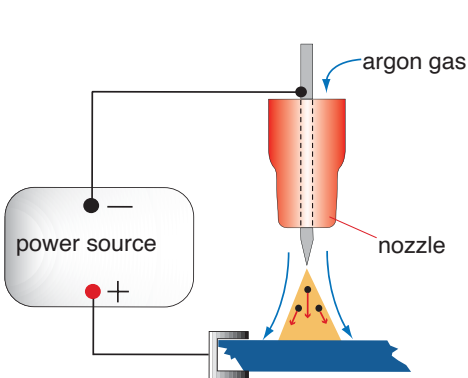

DC TIG welding is a process in which an arc is struck between a TUNGSTEN electrode and the metal work piece. The weld area is shielded by an inert gas flow to prevent contamination of the tungsten, molten pool and weld area.

When the TIG arc is struck the inert gas is ionized and superheated changing it's molecular structure which converts it into a plasma stream. This plasma stream flowing between the tungsten and the work piece is the TIG arc and can be as hot as 19,000°C. It is a very pure and concentrated arc which provides the controlled melting of most metals into a weld pool. TIG welding offers the user the greatest amount of flexibility to weld the widest range of material and thickness and types. DC TIG welding is also the cleanest weld with no sparks or spatter.

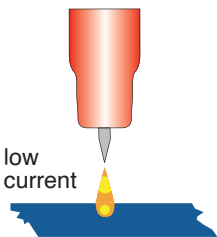

The intensity of the arc is proportional to the current that flows from the tungsten. The welder regulates the welding current to adjust the power of the arc. Typically thin material requires a less powerful arc with less heat to melt the material so less current (amps) is required, thicker material requires a more powerful arc with more heat so more current (amps) are necessary to melt the material.

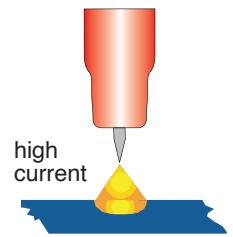

TIG WELDING GUIDE



TIG Welding Fusion Technique

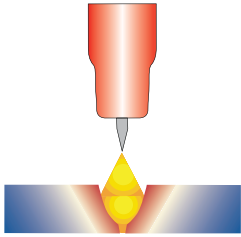

Manual TIG welding is often considered the most difficult of all the welding processes. Because the welder must maintain a short arc length, great care and skill are required to prevent contact between the electrode and the workpiece. Similar to Oxygen Acetylene torch welding, Tig welding normally requires two hands and in most instances requires the welder to manually feed a filler wire into the weld pool with one hand while manipulating the welding torch in the other. However, some welds combining thin materials can be accomplished without filler metal like edge, corner, and butt joints.

This is known as Fusion welding where the edges of the metal pieces are melted together using only the heat and arc force generated by the TIG arc. Once the arc is started the torch tungsten is held in place until a weld pool is created, a circular movement of the tungsten will assist in creating a weld pool of the desired size. Once the weld pool is established tilt the torch at about a 75° angle and move smoothly and evenly along the joint while fusing the materials together.

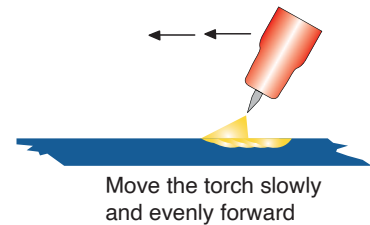
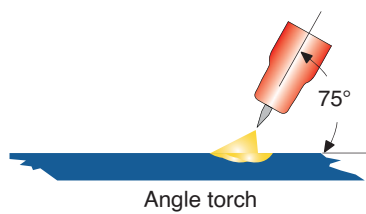
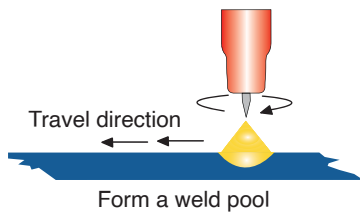

TIG Welding with Filler Wire Technique

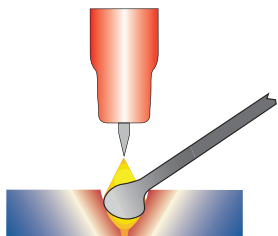

It is necessary in many situations with TIG welding to add a filler wire into the weld pool to build up weld reinforcement and create a strong weld. Once the arc is started the torch tungsten is held in place until a weld pool is created, a circular movement of the tungsten will assist in creating a weld pool of the desired size. Once the weld pool is established tilt the torch at about a 75° angle and move smoothly and evenly along the joint. The filler metal is introduced to the leading edge of the weld pool. The filler wire is usually held at about a 15° angle and fed into the leading edge of the molten pool,

the arc will melt the filler wire into the weld pool as the torch is moved forward. Also a dabbing technique can be used to control the amount of filler wire added, the wire is fed into the molten pool and retracted in a repeating sequence as the torch is moved slowly and evenly forward. It is important during the welding to keep the molten end of the filler wire inside the gas shield as this protects the end of the wire from being oxidised and contaminating the weld pool.

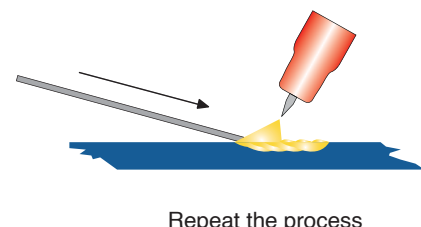
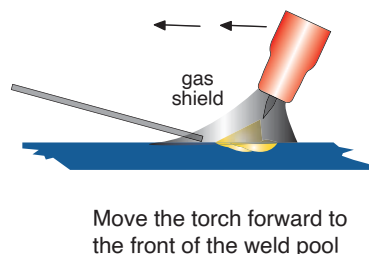
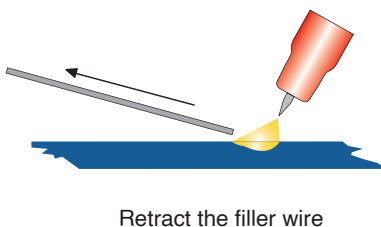
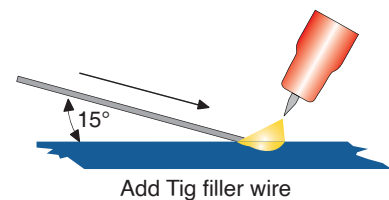
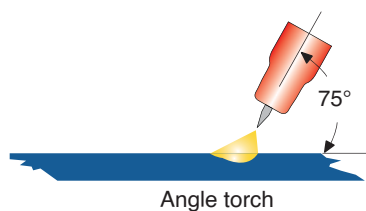
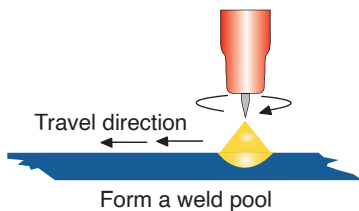

Tungsten Electrodes

Tungsten is a rare metallic element used for manufacturing TIG welding electrodes. The TIG process relies on tungsten's hardness and high-temperature resistance to carry the welding current to the arc. Tungsten has the highest melting point of any metal, 3,410 degrees Celsius. Tungsten electrodes are nonconsumable and come in a variety of sizes, they are made from pure tungsten or an alloy of tungsten and other rare earth elements. Choosing the correct tungsten depends on the material being welded, amps required and whether you are using AC or DC welding current. Tungsten electrodes are colour-coded at the end for easy identification. Below are the most commonly used tungsten electrodes found in the New Zealand and Australian market.

Thoriated

Thoriated tungsten electrodes (AWS classification EWTh-2) contain a minimum of 97.30 percent tungsten and 1.70 to 2.20 percent thorium and are called 2 percent thoriated. They are the most commonly used electrodes today and are preferred for their longevity and ease of use. Thorium however is a low-level radioactive hazard and many users have switched to other alternatives. Regarding the radioactivity, thorium is an alpha emitter but when it is enclosed in a tungsten matrix the risks are negligible. Thoriated tungsten should not get in contact with open cuts or wounds. The more significant danger to welders can occur when thorium oxide gets into the lungs. This can happen from the exposure to vapours during welding or from ingestion of material/dust in the grinding of the tungsten. Follow the manufacturer's warnings, instructions, and the Material Safety Data Sheet (MSDS) for its use.

E3 (Color Code: Turquoise)

E3 tungsten electrodes (AWS classification EWG) contain a minimum of 98% percent tungsten and up to 1.5 percent Lanthanum and small percentages of Zirconium and Yttrium they are called E3 Tungsten. E3 Tungsten Electrodes provide conductivity similar to that of thoriated electrodes. Typically, this means that E3 Tungsten Electrodes are exchangeable with thoriated electrodes without requiring significant welding process changes. E3 deliver superior arc starting, electrode lifetime, and overall cost-effectiveness. When E3 Tungsten Electrodes are compared with 2% thoriated tungsten, E3 requires fewer re-grinds and provides a longer overall lifetime. Tests have shown that ignition delay with E3 Tungsten Electrodes actually improves over time, while 2% thoriated tungsten starts to deteriorate after only 25 starts. At equivalent energy output, E3 Tungsten Electrodes run cooler than 2% thoriated tungsten, thereby extending overall tip lifetime. E3 Tungsten Electrodes work well on AC or DC. They can be used DC electrode positive or negative with a pointed end, or balled for use with AC power sources.

Ceriated (Color Code: Grey)

Ceriated tungsten electrodes (AWS classification EWCe-2) contain a minimum of 97.30 percent tungsten and 1.80 to 2.20 percent cerium and are referred to as 2 percent ceriated. Ceriated tungstens perform best in DC welding at low current settings. They have excellent arc starts at low amperages and become popular in such applications as orbital tube welding, thin sheet metal work. They are best used to weld carbon steel, stainless steel, nickel alloys, and titanium, and in some cases it can replace 2 percent thoriated electrodes. Ceriated tungsten is best suited for lower amperages it should last longer than Thoriated tungsten higher amperage applications are best left to Thoriated or Lanthanated tungsten.

Lanthanated (Color Code: Gold)

Lanthanated tungsten electrodes (AWS classification EWLa-1.5) contain a minimum of 97.80 percent tungsten and 1.30 percent to 1.70 percent lanthanum, and are known as 1.5 percent lanthanated. These electrodes have excellent arc starting, a low burn off rate, good arc stability, and excellent re-ignition characteristics. Lanthanated tungstens also share the conductivity characteristics of 2 percent thoriated tungsten. Lanthanated tungsten electrodes are ideal if you want to optimise your welding capabilities. They work well on AC or DC electrode negative with a pointed end, or they can be balled for use with AC sine wave power sources. Lanthanated tungsten maintains a sharpened point well, which is an advantage for welding steel and stainless steel on DC or AC from square wave power sources.

Zirconiated (Color Code: White)

Zirconiated tungsten electrodes (AWS classification EWZr-1) contain a minimum of 99.10 percent tungsten and 0.15 to 0.40 percent zirconium. Most commonly used for AC welding Zirconiated tungsten produces a very stable arc and is resistant to tungsten spitting. It is ideal for AC welding because it retains a balled tip and has a high resistance to contamination. Its current-carrying capacity is equal to or greater than that of thoriated tungsten. Zirconiated tungsten is not recommended for DC welding.

Tungsten Electrodes Rating for Welding Currents

Tungsten Diameter mm	DC Current Amps Torch Negative 2% Thoriated	AC Current Amps Un-Balanced Wave 0.8% Zirconiated	AC Current Amps Balanced Wave 0.8% Zirconiated
1.0mm	15 - 80	15 - 80	20 - 60
1.6mm	70 - 150	70 - 150	60 - 120
2.4mm	150 - 250	140 - 235	100 - 180
3.2mm	250 - 400	225 - 325	160 - 250
4.0mm	400 - 500	300 - 400	200 - 320

Tungsten Preparation

Always use **DIAMOND** wheels when grinding and cutting. While tungsten is a very hard material, the surface of a diamond wheel is harder, and this makes for smooth grinding. Grinding without diamond wheels, such as aluminium oxide wheels, can lead to jagged edges, imperfections, or poor surface finishes not visible to the eye that will contribute to weld inconsistency and weld defects.

Always ensure to grind the tungsten in a longitudinal direction on the grinding wheel. Tungsten electrodes are manufactured with the molecular structure of the grain running lengthwise and thus grinding crosswise is “grinding against the grain.” If electrodes are ground crosswise, the electrons have to jump across the grinding marks and the arc can start before the tip and wander. Grinding longitudinally with the grain, the electrons flow steadily and easily to the end of the tungsten tip. The arc starts straight and remains narrow, concentrated, and stable.



Electrode Tip/Flat

The shape of the tungsten electrode tip is an important process variable in precision arc welding. A good selection of tip/flat size will balance the need for several advantages. The bigger the flat, the more likely arc wander will occur and the more difficult it will be to arc start. However, increasing the flat to the maximum level that still allows arc start and eliminates arc wander will improve the weld penetration and increase the electrode life. Some welders still grind electrodes to a sharp point, which makes arc starting easier. However, they risk decreased welding performance from melting at the tip and the possibility of the point falling off into the weld pool.



Electrode Included Angle/Taper - DC Welding

Tungsten electrodes for DC welding should be ground longitudinally and concentrically with diamond wheels to a specific included angle in conjunction with the tip/flat preparation. Different angles produce different arc shapes and offer different weld penetration capabilities. In general, blunter electrodes that have a larger included angle provide the following benefits:

- Last Longer
- Have better weld penetration
- Have a narrower arc shape
- Can handle more amperage without eroding.

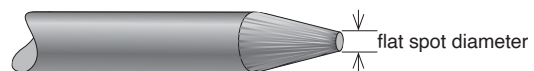

Sharper electrodes with smaller included angle provide:

- Offer less arc weld
- Have a wider arc
- Have a more consistent arc



The included angle determines weld bead shape and size. Generally, as the included angle increases, penetration increases and bead width decreases.

Tungsten Diameter	Diameter at the Tip - mm	Constant Included Angle - Degrees	Current Range Amps	Current Range Pulsed Amps
1.0mm	.250	20	05 - 30	05 - 60
1.6mm	.500	25	08 - 50	05 - 100
1.6mm	.800	30	10 - 70	10 - 140
2.4mm	.800	35	12 - 90	12 - 180
2.4mm	1.100	45	15 - 150	15 - 250
3.2mm	1.100	60	20 - 200	20 - 300
3.2mm	1.500	90	25 - 250	25 - 350

RAZORWELD

ARC630



ARC-AIR GOUGING SET UP



- (1) Select the **CAG** function with the MODE selector button.
- (2) Connect the Arc Air Gouging torch lead to the **Positive** output terminal at the front of the machine and tighten it. Connect the air line to the air supply such as a compressor.
- (3) Connect the earth lead to the **Negative** output terminal at the front of the machine and tighten it.
- (4) Set the required amperage with the amp control knob on the front panel.
See page 25 for suggested amperage settings for DC carbon sizes.

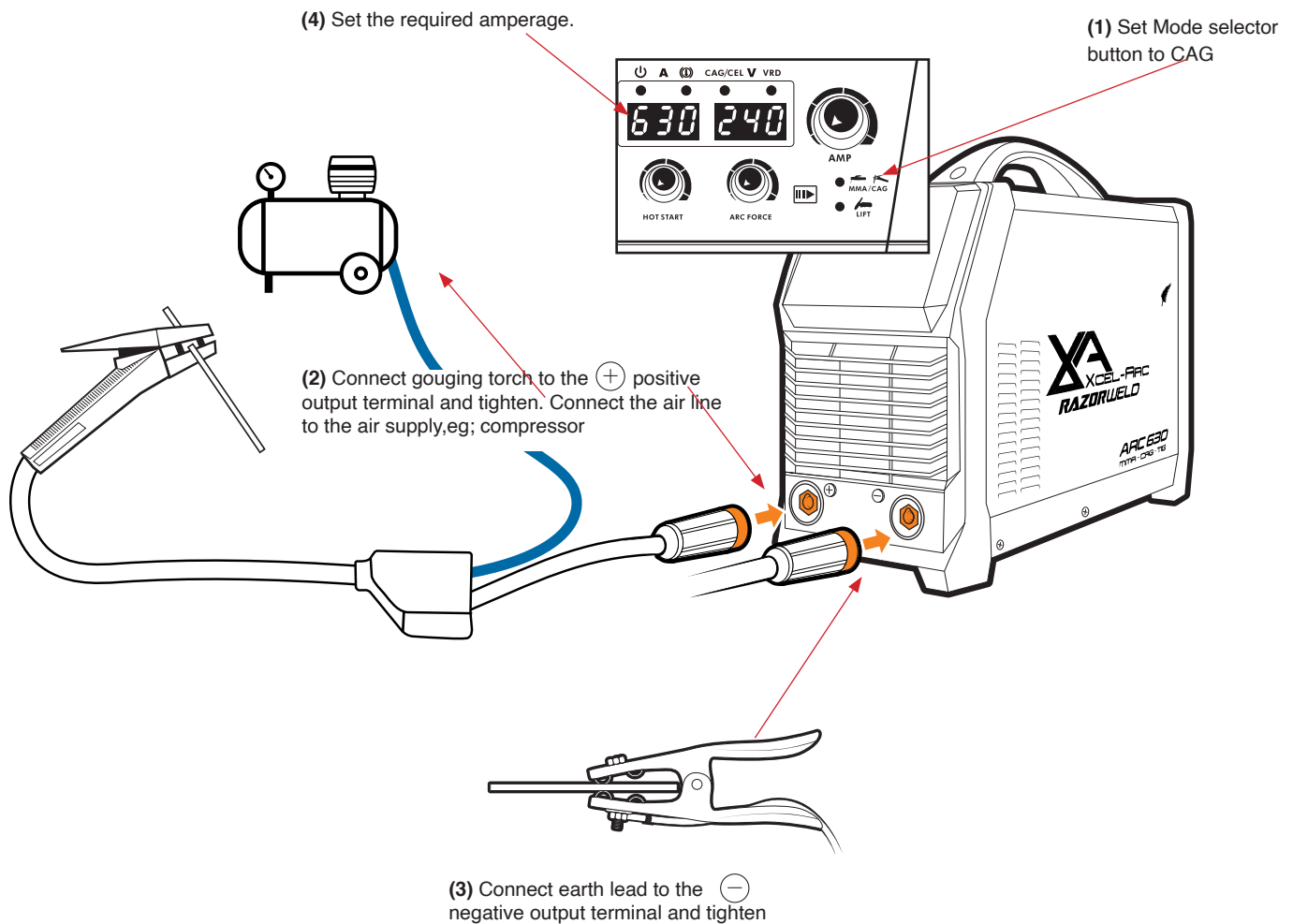

IMPORTANT CAUTION! - When the machine is in GOUGING mode the positive current output line of the machine is live. If the wire feeder power cable is connected to the positive terminal at the rear of the machine it means the wire feeder is live. The same applies when the machine is in MMA mode. Be careful not to place the MIG torch without its gas nozzle fitted to the work piece as it will short out against the work piece and damage the MIG torch head.

Esseti NZ Ltd, authorised representatives or agents of Esseti NZ Ltd will not be liable or responsible for any damage resulting in this situation.

- (5) Slide back the insulating cover of the power block and connect a power lead cable to it, use minimum 50mm² cable up to 10m in length, heavy cable is recommended for a longer power lead. Connect an air line to the air connection at the power block adapter.
- (6) Slide back the insulating cover.
- (7) Rotate the jaw clamp so that the air holes are pointing in the direction you want to gouge.
- (8) Insert a DC gouging carbon into the jaw clamp. the carbon should not extend too far out otherwise the air flow will not meet with the arc gouging area at the end of the carbon to disperse the molten material.



(5) Slide back the insulating cover of the power block and connect a power lead cable to it. Connect an air line to the air connection at the power block adapter.



(6) Slide back the insulating cover



(7) Rotate the jaw clamp so that the air holes are pointing in the direction you want to gouge.



(8) Insert the Carbon between the jaws, the carbon should not extend too far out otherwise the air flow will not meet with the arc gouging zone at the workpiece.

Please see following pages for detailed Arc Air Gouging information.

ARC-AIR GOUGING PROCESS

Air Carbon-Arc Gouging (commonly referred to as Arc-Air Gouging) has been used since the early 1940's when it was initially developed from the Carbon Arc Cutting process that was used to remove welds, rivet heads and cut metal while relying on gravity for removal of the molten material. The gouging process was further developed with the introduction of a jet of compressed air from behind and on the underside of the gouging carbon to remove the molten material. This compressed air was initially applied by a second operator directing an air gun towards the molten pool and was not very successful. With great ingenuity and further development, the Air Carbon-Arc Torch was designed whereby compressed air is fed through the torch head and exited behind and beneath the carbon electrode. The localised air blast provided much faster and more efficient removal of material from the molten pool. Air Carbon-Arc Gouging now provided a perfect process for weld removal, crack removal, back gouging and weld defect repairs for carbon steels, alloy steels, stainless steels and non-ferrous materials.

Air Carbon-Arc Set Up

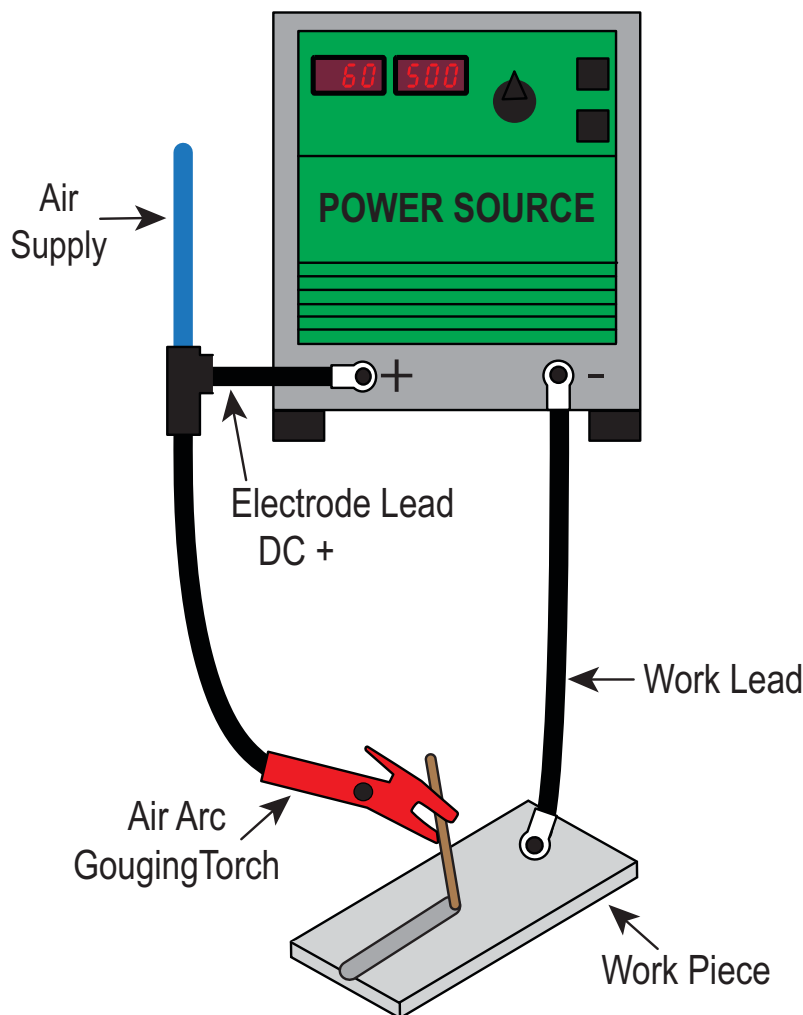

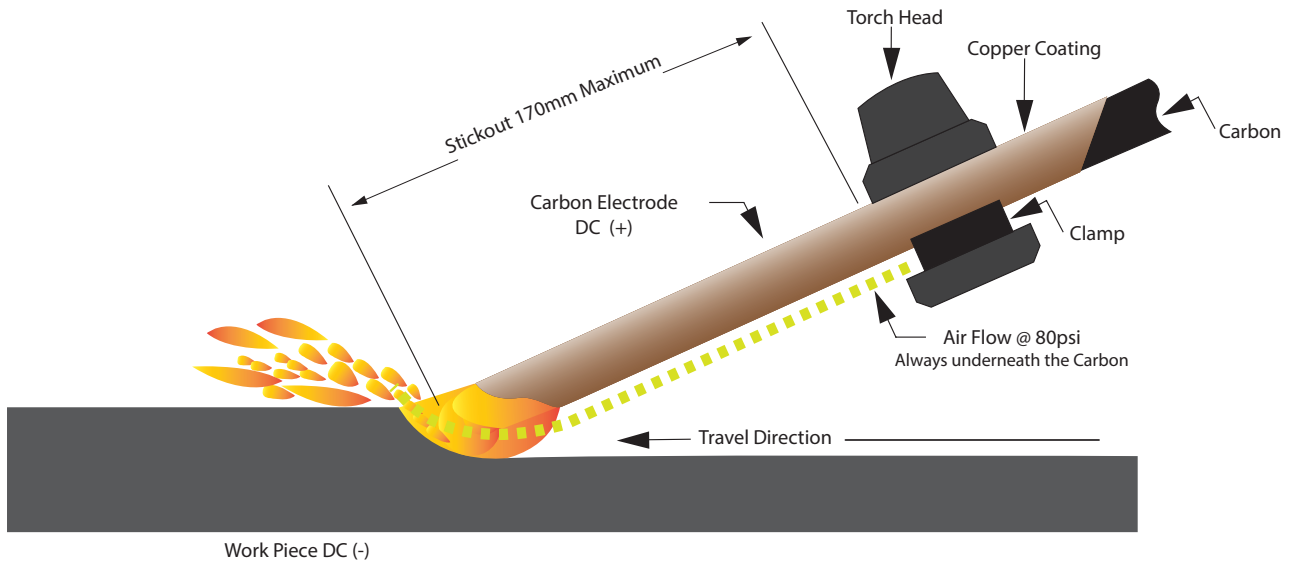

The air jet orifice of the torch head clamp needs to be located underneath the electrode and facing towards the work end of the electrode with the air jet between the electrode and work piece. To avoid damage to the torch head a minimum extension of the electrode should be no less than 45mm. Air pressure should range between 80 psi and 100 psi at the torch and the air supply hose requires an internal diameter of no less than 6.5mm.

Single-phase machines with low open-circuit voltage are not suitable for air carbon arc gouging. Most three-phase welding power sources of sufficient amperage output may be used for air arc gouging. The arc voltage required for air carbon arc gouging and cutting ranges from 35 to 56 volts, therefore the open-circuit voltage needs to be at least 60 volts. For most applications the carbon electrode is connected DC+ and the electrode should not extend more than 170mm from the gouging torch otherwise the air jet becomes ineffectual in removing the molten material.

The air carbon arc process is flexible, efficient, and cost effective on practically any metal; carbon steel, stainless steel and other ferrous alloys; as well as cast iron, aluminium, nickel, copper alloys and other non-ferrous metals. It has found many uses in industry today from metal fabrication, casting finishing, chemical and petroleum industry, construction, mining, general repair and maintenance.

SUGGESTED CURRENT RANGES FOR DC CARBONS

DC Carbon Diameter	DC Carbon Current Range
4.0mm	90 - 150
5.0mm	200 - 250
6.5mm	300 - 400
8.0mm	350 - 450
9.5mm	450 - 600

XA26V TIG TORCH & SPARES (OPTIONAL)



XA26V TIG TORCH Suregrip™ Series

**180AMP AIR COOLED
Gas Valve Torch Head**

Rating: 180A DC, 125A AC @35% duty cycle.

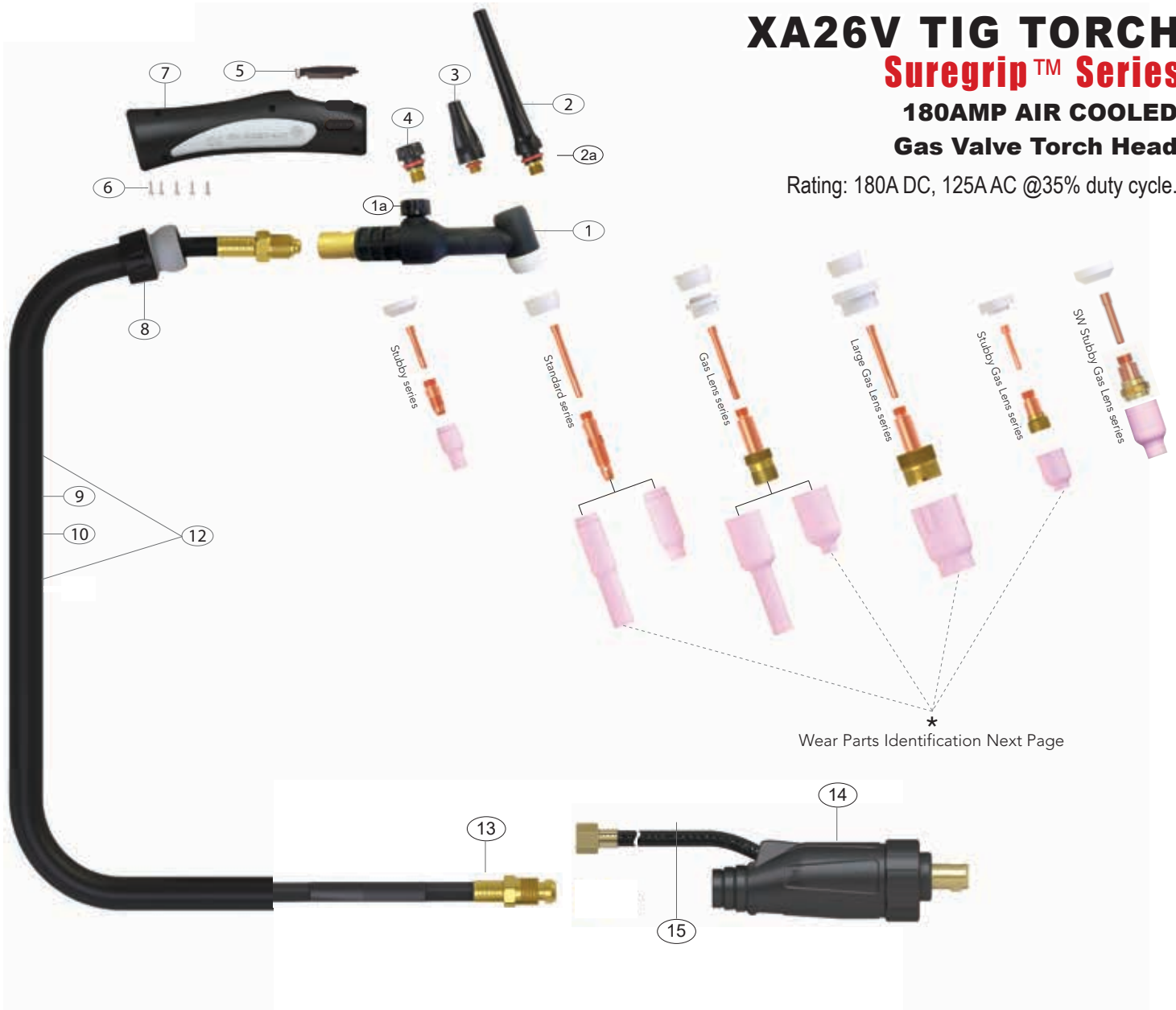

Torch Model Description	Part Number	
	4m	8m
XA26V Suregrip Tig Torch 4m, Surelok Connector QF Gas	XA26V-S112GS4	XA26V-S125GS4
XA26VFX Suregrip Flexi Tig Torch, Surelok Connector, QF Gas	XA26VFX-S112GS4	XA26VFX-S125GS4

Spare Parts

Part Number	Description
1	XA26V Torch Body with Valve
1a	XA26VFX Torch Body Flexible with Valve
2	57Y02 Back Cap Long
2a	98W18 Back Cap O Ring
3	57Y05 Back Cap Medium
4	57Y04 Back Cap Short
5	ERBS Blank Switch Cover (See page 174 for Switch options)
6	ERSP1 Screw Pack
7	ERH200 Large Ergo Tig Handle
8	ERKJ200 Large Knuckle Joint
9	ERLC100-08 Leather Cover x 0.8m
10	ERJK200 Jointing Repair Kit

Spare Parts

Part Number	Description
12	ERCO200-40 Sheath x 4m c/w Leather Cover
	ERCO200-80 Sheath x 8m c/w Leather Cover
13	SL46V28AOB Power Cable x 4m Surelok OB Rubber
	SL46V30AOB Power Cable x 8m Surelok OB Rubber
14	UD1025-38 Dinse Tig Power Cable Connector 10-25
	UD3550-38 Dinse Tig Power Cable Connector 35-50
15	WGCP-1V-58 Gas Hose Assembly x 2m





XA26V TIG TORCH SPARES

				
18CG Cup Gasket	10N22 Collet 1.0mm 10N23 Collet 1.6mm 10N24 Collet 2.4mm 10N25 Collet 3.2mm	10N30 Collet Body 1.0mm 10N31 Collet Body 1.6mm 10N32 Collet Body 2.4mm 10N28 Collet Body 3.2mm	10N50 Alumina Nozzle Ø 6mm #4 10N49 Alumina Nozzle Ø 8mm #5 10N48 Alumina Nozzle Ø 10mm #6 10N47 Alumina Nozzle Ø 11mm #7 10N46 Alumina Nozzle Ø 12.5mm #8 10N45 Alumina Nozzle Ø 16mm #10 10N44 Alumina Nozzle Ø 19mm #12	10N49L Long Alumina Nozzle Ø 8mm #5L 10N48L Long Alumina Nozzle Ø 10mm #6L 10N47L Long Alumina Nozzle Ø 11mm #7L





Stubby Front End Parts

				
18CG20 Stubby Cup Gasket	10N22S Stubby Collet 1.0mm 10N23S Stubby Collet 1.6mm 10N24S Stubby Collet 2.4mm 10N25S Stubby Collet 3.2mm	17CB20 Stubby Collet Body Fits 1.0 - 3.2mm	13N08 Alumina Nozzle Ø 6mm #4 13N09 Alumina Nozzle Ø 8mm #5 13N10 Alumina Nozzle Ø 10mm #6 13N11 Alumina Nozzle Ø 11mm #7 13N12 Alumina Nozzle Ø 13mm #8 13N13 Alumina Nozzle Ø 16mm #10	796F70 Long Alumina Nozzle Ø 5mm #3 796F71 Long Alumina Nozzle Ø 6mm #4 796F72 Long Alumina Nozzle Ø 8mm #5 796F73 Long Alumina Nozzle Ø 10mm #6





Ultra Stubby Gas Lens Front End Parts

			
USTB80300236 Gas Lens Gasket	10N22S Stubby Collet 1.0mm 10N23S Stubby Collet 1.6mm 10N24S Stubby Collet 2.4mm 10N25S Stubby Collet 3.2mm	USTB45V43 Stubby Gas Lens Body 1.6mm USTB45V44 Stubby Gas Lens Body 2.4mm USTB45V45 Stubby Gas Lens Body 3.2mm	53N58 Gas Lens Nozzle Ø 6mm #4 53N59 Gas Lens Nozzle Ø 8mm #5 53N60 Gas Lens Nozzle Ø 10mm #6 53N61 Gas Lens Nozzle Ø 11mm #7 53N61S Gas Lens Nozzle Ø 12.5mm #8

SW Stubby Gas Lens Front End Parts

			
18CG20 Stubby Cup Gasket	10N22S Stubby Collet 1.0mm 10N23S Stubby Collet 1.6mm 10N24S Stubby Collet 2.4mm 10N25S Stubby Collet 3.2mm	45V24S SW Stubby Gas Lens Body 1.0mm 45V25S SW Stubby Gas Lens Body 1.6mm 45V26S SW Stubby Gas Lens Body 2.4mm 45V27S SW Stubby Gas Lens Body 3.2mm	54N16SW Gas Lens Nozzle Ø 10mm #6 54N15SW Gas Lens Nozzle Ø 11mm #7 54N14SW Gas Lens Nozzle Ø 12.5mm #8 54N12SW Gas Lens Nozzle Ø 16.0mm #10

Gas Lens Front End Parts

				
18CG Cup Gasket 54N01 Gas Lens Gasket	10N22 Collet 1.0mm 10N23 Collet 1.6mm 10N24 Collet 2.4mm 10N25 Collet 3.2mm	45V24 Gas Lens Collet Body 1.0mm 45V25 Gas Lens Collet Body 1.6mm 45V26 Gas Lens Collet Body 2.4mm 45V27 Gas Lens Collet Body 3.2mm	54N18 Gas Lens Nozzle Ø 6mm #4 54N17 Gas Lens Nozzle Ø 8mm #5 54N16 Gas Lens Nozzle Ø 10mm #6 54N15 Gas Lens Nozzle Ø 11mm #7 54N14 Gas Lens Nozzle Ø 12.5mm #8 54N19 Gas Lens Nozzle Ø 17mm #11	54N18L Long Gas Lens Nozzle Ø 6mm #4L 54N17L Long Gas Lens Nozzle Ø 8mm #5L 54N16L Long Gas Lens Nozzle Ø 10mm #6L 54N15L Long Gas Lens Nozzle Ø 11mm #7L 54N14L Long Gas Lens Nozzle Ø 12.5mm #8L

Large Gas Lens Front End Parts

				
18CG Cup Gasket 54N63 Large Lens Gasket	10N22 Collet 1.0mm 10N23 Collet 1.6mm 10N24 Collet 2.4mm 10N25 Collet 3.2mm	10N22 Collet 1.0mm 10N23 Collet 1.6mm 10N24 Collet 2.4mm 10N25 Collet 3.2mm	45V0204 Large Gas Lens Body 1.0mm 45V116 Large Gas Lens Body 1.6mm 45V64 Large Gas Lens Body 2.4mm 995795 Large Gas Lens Body 3.2mm	57N75 Large Gas Lens Nozzle Ø 10mm #6 57N74 Large Gas Lens Nozzle Ø 12.5mm #8 53N88 Large Gas Lens Nozzle Ø 16mm #10 53N87 Large Gas Lens Nozzle Ø 19mm #12

ARC AIR GOUGING TORCH, DC CARBONS (OPTIONAL)



ARC AIR GOUGING TORCH

Part-No	Description
K4000	K4000 Arc Air Gouging Torch

Applications: Heavy Duty - highly efficient metal removal tool for fabrication jobs in steel fabrication plants, truck shops, railroads, general engineering shops, farms . . . anywhere people want to save time and money.

Supplied with a 2m power cable complete with power block and air connector. To extend reach extra welding cable is available separately.

Electrode Size: Round - 4.0mm - 12.7mm
Flat - 15.9mm

Air Requirement: 80 PSI - 5.6 kg/cm²
25 CFM - 708 L/min



TORCH SPARE PARTS

Item	Part-No	Description
1	94-433-183	K4000 Insulator
2	94-378-368	K4000 Head
3	94-048-088	K4000 Upper Arm
4	94-433-183-S	K4000 Insulator Screw
5	94-476-066	K4000 Press Lever Insulator
6	94-800-007	K4000 Spring
7	94-104-016	K4000 Valve Bonnet
8	94-103-206	K4000 Torch Body Arm
9	94-170-182	K4000 Connector
10	94-801-011	K4000 Spool Assembly with O-rings
11	94-370-163	K4000 Handle
12	94-632-092	K4000 Hinge Pin

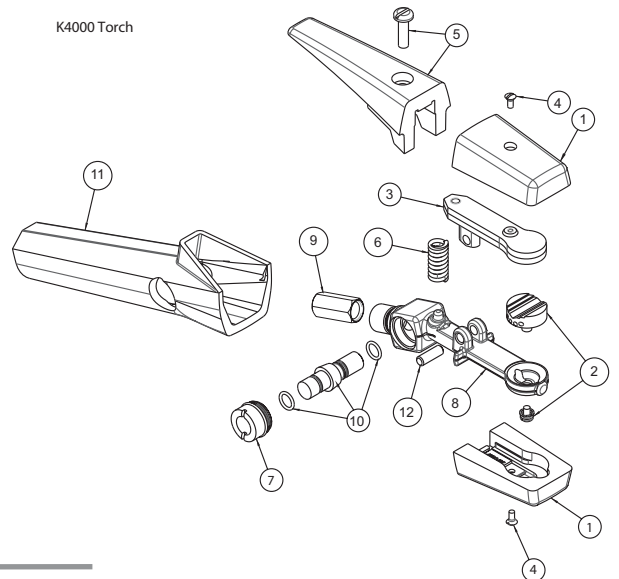

DC GOUGING CARBONS

Part-No	Description	Pkt Qty
DGC40305	Copper Clad DC Gouging Carbon 4.0 x 305mm	100
DGC50305	Copper Clad DC Gouging Carbon 5.0 x 305mm	50
DGC65305	Copper Clad DC Gouging Carbon 6.5 x 305mm	50
DGC80305	Copper Clad DC Gouging Carbon 8.0 x 305mm	50
DGC95305	Copper Clad DC Gouging Carbon 9.5 x 305mm	50
DGCF15948	Copper Clad Flat DC Gouging Carbon 15.9 x 4.8mm	50

Carbon Diameter	DC Carbon Amps DCEP min - max
4.0mm	90 - 150
5.0mm	200 - 280
6.5mm	300 - 400
8.0mm	350 - 450
9.5mm	450 - 600
Flat 15.9 x 4mm	450 - 600



GAS FLOW REGULATORS

The job of the gas flow regulator is to reduce the bottle pressure gas down to a lower pressure and deliver it at a constant flow. This constant flow of gas is usually fed through the welding machine where it is controlled by a solenoid valve, operated when the torch trigger is pulled. Once the gas has passed the solenoid valve it flows down the torch cable exiting at the gas nozzle to protect the weld pool and surrounding area. There are two main types of flow regulators commonly used for MIG and TIG welding applications. Both regulator types perform the same function, but have a different way of setting and measuring the gas flow. A flow-gauge regulator (Fig.1) has a dial-type pressure gauge to measure the cylinder contents and a second gauge to measure and deliver the flow rate required. The flow-meter regulator (Fig.2) has a pressure gauge to measure the cylinder contents and a flow tube assembly to measure and deliver the flow rate required. Some flowmeter regulators will have two flow tube assemblies (Fig.3) typically one is used for supplying gas to the welding machine and the other is used for purging the welding area with gas prior to welding, during welding and post welding and at a separate rate of flow from that being supplied to the welding machine. The amount of gas flow needed to do the job will depend on the welding gas and the job being done, but a common setting to start with is 10 L/min.



Fig.1



Fig.2



Fig.3

SHIELDING GASES

Shielding gases are almost always necessary for MIG and TIG welding processes to protect the weld zone from gases that are contained in the surrounding atmosphere, particularly nitrogen and oxygen. If allowed into the weld zone these gases will contaminate the weld pool resulting in fusion defects also porosity and embrittlement of the weld metal. Selecting the right type of shielding gas depends on the welding process being used and type of material being welded. The MIG process is typically a mixture of Argon and Co₂ (AR90% Co₂ 10%) or pure Co₂ for steel welding applications, other specialised mixtures of Argon, Co₂, and Oxygen are available for stainless steel welding but with welding aluminium pure Argon is almost always used. The TIG welding process almost always requires 100% Argon for welding of all materials, however in some specialised applications Helium, or a Helium mix are sometimes used. Today with the multitude of gas mixes available through a number of different suppliers, it is difficult to list and recommend which gas mix is better for which job. If you are unsure about what gas or gas mix to use we recommend you discuss with your application local gas suppliers or your Esseti technical representative.

MMA (STICK) WELDING TROUBLE SHOOTING



The following chart addresses some of the common problems of MMA welding. In all cases of equipment malfunction, the manufacturer's recommendations should be strictly adhered to and followed.

1: No arc	
<i>Possible Reason</i>	<i>Suggested Remedy</i>
Incomplete welding circuit	Check earth lead is connected. Check all cable connections.
Wrong mode selected	Check the MMA selector switch is selected
No power supply	Check that the machine is switched on and has a power supply
2: Porosity – small cavities or holes resulting from gas pockets in weld metal.	
<i>Possible Reason</i>	<i>Suggested Remedy</i>
Arc length too long	Shorten the arc length
Work piece dirty, contaminated or moisture	Remove moisture and materials like paint, grease, oil, and dirt, including mill scale from base metal
Damp electrodes	Use only dry electrodes
3: Excessive Spatter	
<i>Possible Reason</i>	<i>Suggested Remedy</i>
Amperage too high	Decrease the amperage or choose a larger electrode
Arc length too long	Shorten the arc length
4: Weld sits on top, lack of fusion	
<i>Possible Reason</i>	<i>Suggested Remedy</i>
Insufficient heat input	Increase the amperage or choose a larger electrode
Work piece dirty, contaminated or moisture	Remove moisture and materials like paint, grease, oil, and dirt, including mill scale from base metal
Poor welding technique	Use the correct welding technique or seek assistance for the correct technique
5: Lack of penetration	
<i>Possible Reason</i>	<i>Suggested Remedy</i>
Insufficient heat input	Increase the amperage or choose a larger electrode
Poor welding technique	Use the correct welding technique or seek assistance for the correct technique
Poor joint preparation	Check the joint design and fit up, make sure the material is not too thick. Seek assistance for the correct joint design and fit up
6: Excessive penetration - burn through	
<i>Possible Reason</i>	<i>Suggested Remedy</i>
Excessive heat input	Reduce the amperage or use a smaller electrode
Incorrect travel speed	Try increasing the weld travel speed
7: Uneven weld appearance	
<i>Possible Reason</i>	<i>Suggested Remedy</i>
Unsteady hand, wavering hand	Use two hands where possible to steady up, practise your technique
8: Distortion – movement of base metal during welding	
<i>Possible Reason</i>	<i>Suggested Remedy</i>
Excessive heat input	Reduce the amperage or use a smaller electrode
Poor welding technique	Use the correct welding technique or seek assistance for the correct technique
Poor joint preparation and or joint design	Check the joint design and fit up, make sure the material is not too thick. Seek assistance for the correct joint design and fit up
9: Electrode welds with different or unusual arc characteristic	
<i>Possible Reason</i>	<i>Suggested Remedy</i>
Incorrect polarity	Change the polarity, check the electrode manufacturer for correct polarity

TIG WELDING TROUBLE SHOOTING

The following chart addresses some of the common problems of TIG welding. In all cases of equipment malfunction, the manufacturer's recommendations should be strictly adhered to and followed.

1: Tungsten burning away quickly	
<i>Possible Reason</i>	<i>Suggested Remedy</i>
Incorrect Gas or No Gas	Use pure Argon. Check cylinder has gas, connected, turned on and torch valve is open
Inadequate gas flow	Check the gas is connected, check hoses, gas valve and torch are not restricted.
Back cap not fitted correctly	Make sure the torch back cap is fitted so that the o-ring is inside the torch body
Torch connected to DC +	Connect the torch to the DC- output terminal
Incorrect tungsten being used	Check and change the tungsten type if necessary
Tungsten being oxidised after weld is finished	Keep shielding gas flowing 10–15 seconds after arc stoppage. 1 second for each 10 amps of weld current.
2: Contaminated tungsten	
<i>Possible Reason</i>	<i>Suggested Remedy</i>
Touching tungsten into the weld pool	Keep tungsten from contacting weld puddle. Raise the torch so that the tungsten is off of the work piece 2 - 5mm
Touching the filler wire to the tungsten	Keep the filler wire from touching the tungsten during welding, feed the filler wire into the leading edge of the weld pool in front of the tungsten
3: Porosity - poor weld appearance and colour	
<i>Possible Reason</i>	<i>Suggested Remedy</i>
Wrong gas / poor gas flow /gas leaks	Use pure argon.Gas is connected, check hoses, gas valve and torch are not restricted. Set the gas flow between 6-12 l/min. Check hoses and fittings for holes, leaks etc.,
Contaminated base metal	Remove moisture and materials like paint, grease, oil, and dirt from base metal
Contaminated filler wire	Remove all grease, oil, or moisture from filler metal.
Incorrect filler wire	Check the filler wire and change if necessary
4: Yellowish residue / smoke on the alumina nozzle & discoloured tungsten	
<i>Possible Reason</i>	<i>Suggested Remedy</i>
Incorrect Gas	Use pure Argon gas
Inadequate gas flow	Set the gas flow between 10 - 15 l/min flow rate
Alumina gas nozzle too small	Increase the size of the alumina gas nozzle
5: Unstable Arc during DC welding	
<i>Possible Reason</i>	<i>Suggested Remedy</i>
Torch connected to DC +	Connect the torch to the DC- output terminal
Contaminated base metal	Remove materials like paint, grease, oil, and dirt, including mill scale from base metal.
Tungsten is contaminated	Remove 10mm of contaminated tungsten and re grind the tungsten
Arc length too long	Lower torch so that the tungsten is off of the work piece 2 - 5mm
7: Arc wanders during DC welding	
<i>Possible Reason</i>	<i>Suggested Remedy</i>
Poor gas flow	Check and set the gas flow between 10 - 15 l/min flow rate
Incorrect arc length	Lower torch so that the tungsten is off of the work piece 2 - 5mm
Tungsten incorrect or in poor condition	Check that correct type of tungsten is being used. Remove 10mm from the weld end of the tungsten and re sharpen the tungsten
Poorly prepared tungsten	Grind marks should run lengthwise with tungsten, not circular. Use proper grinding method and wheel.
Contaminated base metal or filler wire	Remove contaminating materials like paint, grease, oil, and dirt, including mill scale from base metal. Remove all grease, oil, or moisture from filler metal.
8: Arc difficult to start or will not start DC welding	
<i>Possible Reason</i>	<i>Suggested Remedy</i>
Incorrect machine set up	Check machine set up is correct
No gas, incorrect gas flow	Check the gas is connected and cylinder valve open, check hoses, gas valve and torch are not restricted. Set the gas flow between 10 - 15 l/min flow rate
Incorrect tungsten size or type	Check and change the size and or the tungsten if required
Loose connection	Check all connectors and tighten
Earth clamp not connected to work	Connect the earth clamp directly to the work piece wherever possible

LIST OF ERROR CODES



Error Type	Error code	Description	Lamp status
Thermal relay	E01	Over-heating(1st thermal relay)	Yellow lamp(thermal protection) always on
	E02	Over-heating(2nd thermal relay)	Yellow lamp(thermal protection) always on
	E03	Over-heating(3rd thermal relay)	Yellow lamp(thermal protection) always on
	E04	Over-heating(4th thermal relay)	Yellow lamp(thermal protection) always on
	E09	Over-heating(Program in default)	Yellow lamp(thermal protection) always on
Welding machine	E10	Phase loss	Yellow lamp(thermal protection) always on
	E11	No water	Yellow lamp(lack water) always on
	E12	No gas	Red lamp always on
	E13	Under voltage	Yellow lamp(thermal protection) always on
	E14	Over voltage	Yellow lamp(thermal protection) always on
	E15	Over current	Yellow lamp(thermal protection) always on
	E16	Wire feeder over load	
Switch	E20	Button fault on operating panel when switch on the machine	Yellow lamp(thermal protection) always on
	E21	Other faults on operating panel when switch on the machine	Yellow lamp(thermal protection) always on
	E22	Torch fault when switch on the machine	Yellow lamp(thermal protection) always on
	E23	Torch fault during normal working process	Yellow lamp(thermal protection) always on
Accessory	E30	Cutting torch disconnection	Red lamp blink
	E31	Water cooler disconnection	Yellow lamp(lack water) always on
Communication	E40	Connection problem between wire feeder and power source	
	E41	Communication error	

ESSETI New Zealand Limited ('us', 'we') warrants that the products bearing the brand names ESSETI, XCEL-ARC, RAZORWELD, RAZORCUT, JASIC, VIPER, T&R, XCEL-GAS, Otos, Servore, TECNA & HIT-8SS supplied by us and purchased by you from an Authorised ESSETI (NZ) Ltd. Distributor are free of Material and Faulty Workmanship Defects except for those products listed under 'Warranty Exclusions' and whilst any claim is made subject to the following terms and conditions.

Your rights under the New Zealand Consumer Law may not be limited by a defined time. However, New Zealand Consumer Law does recognise that the relevant time period can vary from product to product, depending on factors such as the nature of the product and the price. Esseti NZ Ltd. adopts the same approach. As you can appreciate, the type of remedy we can offer you may also vary depending on how long it takes you to return the product to us.

WARRANTY PERIOD

We offer the following 'Warranty Periods' from 'date of purchase':

An Extended Warranty Period of 6 months total shall apply only to Machinery where offered and warranty is registered online.

We offer the following 'Warranty Periods' effective from the 'date of purchase':

XCEL-ARC, Inverter MIG/SWF/MTS, MMA/TIG, TIG ACDC, Plasma (Power Source Only*)	2 Years
RAZORWELD, Inverter MIG/SWF/MTS, MMA/TIG, TIG ACDC (Power Source Only*)	3 Years
RAZORCUT, Inverter Plasma (Power Source Only*)	3 Years
VIPER MIG185,165 Viper TIG180ACDC (Power Source Only*)	2 Years
VIPER ARC140, VIPER ARC160, VIPER CUT30, (Power Source Only*)	1 Year
VIPER TIG200P, VIPER SYNERGIC MIG 120,135 (Power Source Only*)	1 Year
JASIC, Inverter MIG/SWF/MTS, MMA/TIG, TIG ACDC, Plasma (Power Source Only*)	2 Years
XCEL-ARC & RAZORWELD, Water Coolers, PAPR Air Blower Unit	1 Year
XCEL-GAS, Gas Cutting and Welding Torches	3 Months
XCEL-GAS, Straight Line & Gas Cutting Machines (Machine Only*)	1 Year
XCEL-GAS, Regulators Argon/ Acetylene / Oxygen / LPG / Bobbin Flowmeter	1 Year
XCEL-ARC, Automatic Welding Helmet	2 Years
RAZORSHIELD Digital Welding Mask & Goggle Kit , Automatic Welding Helmets	2 Year
TECNA, Spot Welding Machines (Power Source Only*)	1 Year
ALL WELDING TORCHES – GMAW / GTAW / MMAW / PLASMA	3 Months
ALL EARTH LEADS, INTERCONNECTING CABLES, GAS HOSES	3 Months

(* This only covers manufacturing faults on any torches, cables and other accessories, either included with a machine kitset or sold separately, for the first three months after date of purchase.



**REGISTER YOUR MACHINE ONLINE TO RECEIVE AN
ADDITIONAL 6 MONTHS ON YOUR WARRANTY**

Visit XcelArc.nz/warranty-registration/ to register your machine.

WARRANTY / RETURNS / EXCHANGES

Our Warranty Returns Policy recognises all and any rights you have under New Zealand Consumer Law and other relevant laws.

You shall inspect the goods on delivery and shall within seven (7) days of delivery (time being of the essence) notify the Esseti NZ Ltd. Authorised Distributor from whom you purchased the goods of any alleged defect, shortage in quantity, damage or failure to comply with the description or quote.

You shall also afford Esseti NZ Ltd. the opportunity to inspect the goods within a reasonable time following delivery if you believe the goods are defective in any way.

If you shall fail to comply with these provisions the goods shall be presumed to be free from any defect or damage. For defective goods and where permissible by law, Esseti NZ Ltd. reserves the right to repair or otherwise remedy the defect prior to issuing replacement goods or refunding the purchase price.

If the goods are being purchased for a business purpose then the purchaser acknowledges that the Consumer Guarantees Act will not apply.

The New Zealand Sales of Goods Act applies when goods are not covered by the Consumer Guarantees Act. You may be able to get a full refund or compensation if the trader doesn't have the right to sell the goods, or the goods are:

- not of 'merchantable quality' (so defective that most people wouldn't want them)
- not fit for their normal purpose
- poorer quality than a sample you were shown
- not suitable for what you told the trader you wanted the goods for
- not matching their description

If there has been a misrepresentation you may have rights under the Fair Trading Act or the Contractual Remedies Act and therefore also entitled to, at the consumer's discretion, either a refund of the purchase price of the goods, or repair of the goods, or replacement of the goods.

Returns will only be accepted provided that:

- (a) You have complied with the provisions outlined above, and
- (b) where the goods are unable to be repaired, the goods are returned at your cost within thirty (30) days of the delivery date, and
- (c) Esseti NZ Ltd. will not be liable for goods which have not been stored or used in a proper manner, and
- (d) the goods are returned in the condition in which they were delivered and with all packaging material, brochures and instructional material in as new condition as is reasonably possible in the circumstances.

Esseti NZ Ltd Accepts no responsibility for any products lost, damaged or mislaid whilst in transit. Esseti NZ Ltd. may (at their sole discretion) accept the return of goods for credit but this may incur a handling fee of up to fifteen percent (15%) of the value of the returned Goods plus any freight costs.

MAKING A CLAIM

If you wish to make a claim under this Warranty, you should:

- Return the product to the point of purchase either in person or via prepaid courier; or
- Contact us by Telephone – Esseti NZ Ltd – 06 355 1103

When returned, the product must be accompanied with the original Receipt or Tax Invoice clearly showing the purchase date and disclosing the purchase price. All costs of installation, cartage, freight, travelling expenses, hiring tools and insurance are paid by the Customer. To the extent permitted by law, our total liability for loss or damage of every kind related to the goods in any way whatsoever is limited to the amount paid to the retailer by you for the goods or the value of the goods. No responsibility will be taken for any products lost, damaged or mislaid whilst in transit.

WARRANTY EXCLUSIONS

This Warranty covers Material and Faulty Workmanship defects only.

This Warranty does not cover damage caused by:

- Normal wear and tear due to usage
- Misuse or abusive use of the machine and/or failure to correctly follow set up or operating instructions supplied with these products
- Failure to clean or improper cleaning of the product
- Failure to maintain the equipment such as regular services, etc.
- Incorrect voltage or non-authorized electrical connections
- Improper installation
- Use of non-authorized/non-standard parts
- Abnormal product performance caused by any ancillary equipment interference or other external factors
- Failure or any breakage caused by overload, dropping or abusive treatment or use by the customer
- Repair, modifications or other work carried out on the product other than by an Esseti-Authorised Service Agent

Unless it is a manufacturing fault, this Warranty does not cover the following parts:

• **All Batteries, including Button Type and Cell Type Batteries**

• **MIG Welding Torch Consumables, such as:**

Gas Nozzles, Gas Diffusers, Contact Tip Holders, Contact Tips, Swan Necks, Triggers, Handles, Liners, Euro Block, Shroud Springs, Knobs, All XCEL-ARC / Magmaweld Mig Welding Wires & Electrodes, Arc Leads, Welding Cable, Electrode Holder, Earth Clamps

• **MMA & TIG Welding Torch Consumables, such as:**

Tungsten Electrodes, Collet, Collet Body, Alumina Nozzle, Torch Head, Torch Head water Cooled, Torch Head Flexible, Back Caps, Gas Lens, Torch Handle, Cup Gasket, Torch Body Gas Valve, O-ring, All XCEL-ARC TIG Welding Rods, All XCEL-ARC / Magmaweld Electrodes, Arc Leads, Welding Cable, Electrode Holder, Earth Clamps

• **PLASMA Cutting Torches Consumables, such as:**

All Cutting Tips, All Diffuser/Swirl Ring, All Electrodes, Retaining Caps, Nozzle Springs, All Spacers, All Shield Caps, All Air and Power Cables, All Switches, All O-rings, All Springs, All Circle Guides and Cutting Kits, Torch Bodies, Air Filter Regulator, Welding Cable, Earth Clamps

• **Gas Welding & Cutting Torch and Straight Line Cutting Machine Consumables and Fittings, such as:**

All Cutting, Welding & Brazing Tips, Adaptors, Hoses, Fittings, Tracks and associated parts

• **Automatic Welding & Cutting Carriage Machine Parts, such as:**

Input Cord, Inter-connecting Power Cord, Triggering Cable

This Warranty does not cover products purchased:

- Without the provision of a suitable Receipt or Tax Invoice that clearly provides proof of purchase as outlined above
- At an auction or from a private seller
- Unless it is a manufacturing fault, this Warranty does not apply to any products sold to Hire Companies.

These conditions may only be varied with the written approval of the Directors of Esseti NZ Limited.

REMEMBER TO RETAIN YOUR ORIGINAL INVOICE FOR PROOF OF PURCHASE.



Esseti New Zealand Limited

PO Box 4189, Palmerston North - 4442

Phone: 06 355 1103

Fax: (06) 354 2437

Email: sales@esseti.co.nz

www.esseti.co.nz